

# **IEEE Standard Definition, Specification, and Analysis of Systems Used for Supervisory Control, Data Acquisition, and Automatic Control**

Sponsor  
**Substations Committee  
of the  
IEEE Power Engineering Society**

Approved March 17, 1994  
**IEEE Standards Board**

Approved January 3, 1995  
**American National Standards Institute**

**Abstract:** Distributed multi-computer master stations and distributed remote terminal units (RTUs) are introduced. Submaster RTUs used in an automated distribution system with downstream feeder RTUs is defined. Local area networks with master stations are discussed. Intelligent electronic devices (IEDs) with respect to their interface to RTUs and master stations are defined. New surge withstand capability (SWC) standards and their applicability to SCADA is shown. An example channel loading calculation is provided.  
**Keywords:** automatic control, data acquisition, SCADA, supervisory control

---

The Institute of Electrical and Electronics Engineers, Inc.  
345 East 47th Street, New York, NY 10017-2394, USA  
Copyright © 1994 by the Institute of Electrical and Electronics Engineers, Inc.  
All rights reserved. Published 1994. Printed in the United States of America.  
ISBN 1-55937-429-2

*No part of this publication may be reproduced in any form, in an electronic retrieval system or otherwise, without the prior written permission of the publisher.*

**IEEE Standards** documents are developed within the Technical Committees of the IEEE Societies and the Standards Coordinating Committees of the IEEE Standards Board. Members of the committees serve voluntarily and without compensation. They are not necessarily members of the Institute. The standards developed within IEEE represent a consensus of the broad expertise on the subject within the Institute as well as those activities outside of IEEE that have expressed an interest in participating in the development of the standard.

Use of an IEEE Standard is wholly voluntary. The existence of an IEEE Standard does not imply that there are no other ways to produce, test, measure, purchase, market, or provide other goods and services related to the scope of the IEEE Standard. Furthermore, the viewpoint expressed at the time a standard is approved and issued is subject to change brought about through developments in the state of the art and comments received from users of the standard. Every IEEE Standard is subjected to review at least every five years for revision or reaffirmation. When a document is more than five years old and has not been reaffirmed, it is reasonable to conclude that its contents, although still of some value, do not wholly reflect the present state of the art. Users are cautioned to check to determine that they have the latest edition of any IEEE Standard.

Comments for revision of IEEE Standards are welcome from any interested party, regardless of membership affiliation with IEEE. Suggestions for changes in documents should be in the form of a proposed change of text, together with appropriate supporting comments.

Interpretations: Occasionally questions may arise regarding the meaning of portions of standards as they relate to specific applications. When the need for interpretations is brought to the attention of IEEE, the Institute will initiate action to prepare appropriate responses. Since IEEE Standards represent a consensus of all concerned interests, it is important to ensure that any interpretation has also received the concurrence of a balance of interests. For this reason IEEE and the members of its technical committees are not able to provide an instant response to interpretation requests except in those cases where the matter has previously received formal consideration.

Comments on standards and requests for interpretations should be addressed to:

Secretary, IEEE Standards Board  
445 Hoes Lane  
P.O. Box 1331  
Piscataway, NJ 08855-1331  
USA

IEEE standards documents may involve the use of patented technology. Their approval by the Institute of Electrical and Electronics Engineers does not mean that using such technology for the purpose of conforming to such standards is authorized by the patent owner. It is the obligation of the user of such technology to obtain all necessary permissions.
---

## Introduction

(This introduction is not a part of IEEE Std C37.1-1994, IEEE Standard Definition, Specification, and Analysis of Systems Used for Supervisory Control, Data Acquisition, and Automatic Control.)

This standard applies to systems used for monitoring, switching, and controlling electric apparatus in unattended or attended substations, generating stations, and power utilization and conversion facilities. It does not apply to equipment designed for the automatic protection of power system apparatus or for switching of communication circuits. The requirements of this standard are in addition to those contained in standards relating to the individual devices (e.g., switchgear).

This is a significant revision of IEEE Std C37.1-1987 . This revision reflects current technology that is generally being provided to meet the requirements of utilities today. Originally, this standard was a section of ANSI C37.2-1970 , which also contained device function numbers. ANSI C37.2-1970 was revised into two standards: IEEE Std C37.1-1979 , Standard Definition, Specification, and Analysis of Manual, Automatic, and Supervisory Station Control and Data Acquisition, and IEEE Std C37.2-1979 , Electrical Power System Device Function Numbers. Previous editions were approved by the IEEE Standards Institute in 1962, 1956, 1945, and 1937. The original work on this subject was done by the American Institute of Electrical Engineers (now the Institute of Electrical and Electronics Engineers) and published in 1928 as AIEE No 26. The latest revision of the standard on Electrical Power System Device Function Numbers is IEEE Std C37.2-1991 .<sup>1</sup>

This standard applies to a rapidly changing technology. It is anticipated that frequent revision may be desirable. This revision, prepared by the Electric Network Control Systems Standards Working Group of the Data Acquisition, Processing, and Control Systems Subcommittee of the IEEE Substations Committee, is an attempt to bring the standard up to date and further broaden its applicability with respect to control, supervisory, and telemetering, for greater use in many industries.

IEEE Tutorial Course Text 91 EHO 337-6 PWR [B26]<sup>2</sup> is recommended for those not familiar with Supervisory Systems. In addition, the corresponding Tutorial Video Tape HVO 245-1-POT [B27] is also recommended. Both are available from the IEEE Service Center.

At the time that this standard was completed, Working Group C3, Electric Network Control Systems Standards, of the Data Acquisition, Processing, and Control Systems Subcommittee, had the following membership:

### **Floyd W. Greenway, *Chair***

W. J. Ackerman  
G. J. Bartok  
W. R. Block  
D. L. Carr  
D. M. Clark  
K. L. Cooley  
R. W. Corlew  
G. J. Crask  
J. G. Cupp  
J. C. DiMatteo  
T. L. Doern  
M. J. Dood

J. W. Evans  
R. J. Farquharson  
D. C. Gregory  
J. E. Holladay  
A. P. Johnson  
D. L. Johnson  
D. F. Koenig  
T. L. Krummrey  
L. W. Kurtz, Jr.  
C. T. Lindeberg  
G. L. Luri

J. D. McDonald  
J. S. Oswald  
W. B. Prystajeky  
R. R. Schoetker  
S. C. Sciacca  
J. Singletary, Jr.  
A. R. Skopp  
H. L. Smith  
R. C. Sodergren  
S. R. Sykes  
J. T. Tengdin  
W. L. Yeager

<sup>1</sup>Information on references can be found in clause 2.

<sup>2</sup>The numbers in brackets correspond to those bibliographical items listed in annex C.

At the time that this standard was completed, the Data Acquisition, Processing, and Control Systems Subcommittee had the following membership:

**John D. McDonald, Chair**

W. J. Ackerman  
G. J. Bartok  
W. R. Block  
D. L. Carr  
D. M. Clark  
K. L. Cooley  
R. W. Corlew  
J. G. Cupp  
T. L. Doern  
J. W. Evans  
R. J. Farquharson

F. W. Greenway  
D. C. Gregory  
J. E. Holladay  
K. K. Jackson  
D. L. Johnson  
D. F. Koenig  
R. L. Kreger  
T. L. Krummrey  
L. W. Kurtz, Jr.  
C. T. Lindeberg  
J. S. Oswald

W. B. Prystajeky  
B. D. Russell  
S. C. Sciacca  
J. Singletary, Jr.  
A. R. Skopp  
H. L. Smith  
R. C. Sodergren  
S. R. Sykes  
J. T. Tengdin  
A. D. Watson  
W. L. Yeager

To expedite this extensive revision of the standard, individual clauses of the document were assigned to Clause Coordinators, who lead the effort for that clause. The Clause Coordinators and Overall Text Coordinators were:

<b>Clause</b>	<b>Clause Coordinator</b>
1. Scope	J. D. McDonald
2. References	J. G. Cupp
3. Definitions	L. W. Kurtz, Jr.
4. Functional characteristics	F. W. Greenway
5. Interfaces	S. R. Sykes
6. Environmental conditions	G. J. Bartok
7. Characteristics	R. C. Sodergren
8. Marking	H. L. Smith
9. Tests and inspections	T. L. Doern
10. Documentation	H. L. Smith

Overall Text Coordinators: J. D. McDonald, F. W. Greenway

Special thanks to Thercia McVay, who reviewed and commented on all drafts of this document regarding format and consistency, and who input the entire document, including all the tables and figures.

The following persons were on the delegation of authority balloting committee:

W. J. Ackerman  
B. Y. Afshar  
S. J. Arnot  
A. Baker  
N. Barbeito  
G. J. Bartok  
B. Becer  
K. M. Bevins  
M. J. Bio  
K. L. Black  
C. J. Blattner  
W. Block  
S. Boggs  
P. C. Bolin  
S. D. Brown  
J. C. Burke  
J. B. Cannon  
R. E. Carberry  
D. Charbonnet  
F. Y. Chu  
D. M. Clark  
J. R. Clayton  
R. G. Cottrell  
E. F. Counsel  
W. K. Daily  
F. A. Denbrock  
C. C. Diamond  
W. B. Dietzman

T. L. Doern  
C. Durand  
J. W. Evans  
L. N. Ferguson  
G. G. Flaig  
D. L. Garrett  
F. W. Greenway  
J. Grzan  
D. L. Harris  
J. E. Holladay  
M. L. Holm  
Z. Kapelina  
R. P. Keil  
D. F. Koenig  
T. J. Kolenda  
A. E. Kollar  
E. Kolodziej, Jr.  
T. L. Krummrey  
L. W. Kurtz  
D. N. Laird  
L. M. Laskowski  
A. A. Liebold  
C. T. Lindeberg  
H. P. Lips  
R. Matulic  
J. D. McDonald  
T. S. Mc Lenahan  
A. P. Meliopoulos

P. R. Nannery  
R. S. Nowell  
E. V. Olavarria  
J. T. Orrell  
J. S. Oswald  
S. G. Patel  
R. J. Perina  
K. Pettersson  
W. B. Prystajecy  
J. F. Quinata  
D. G. Rishworth  
B. D. Russell  
J. Sabath  
S. C. Sciacca  
F. C. Shainauskas  
B. Sojka  
R. C. St. Clair  
R. P. Stewart  
W. K. Switzer  
E. R. Taylor, Jr.  
J. T. Tengdin  
H. Thakar  
C. F. Todd  
D. R. Torgerson  
L. F. Volf, Jr.  
A. D. Watson  
R. J. Wehling  
W. M. Werner

When the IEEE Standards Board approved this standard on March 17, 1994, it had the following membership:

**Wallace S. Read**, *Chair*  
**Donald C. Loughry**, *Vice Chair*  
**Andrew G. Salem**, *Secretary*

Gilles A. Baril  
Bruce B. Barrow  
José A. Berrios de la Paz  
Clyde R. Camp  
James Costantino  
Stephen L. Diamond  
Donald C. Fleckenstein  
Jay Forster\*  
Ramiro Garcia

Donald N. Heirman  
Richard J. Holleman  
Jim Isaak  
Ben C. Johnson  
Sonny Kasturi  
Lorraine C. Kevra  
E. G. "Al" Kiener  
Ivor N. Knight

Joseph L. Koepfinger\*  
D. N. "Jim" Logothetis  
L. Bruce McClung  
Marco W. Migliaro  
Mary Lou Padgett  
Arthur K. Reilly  
Ronald H. Reimer  
Gary S. Robinson  
Leonard L. Tripp

\*Member Emeritus

Also included are the following nonvoting IEEE Standards Board liaisons:

Satish K. Aggarwal  
James Beall

Richard B. Engelman

David E. Soffrin  
Stanley I. Warshaw

Rochelle L. Stern, *IEEE Standards Project Editor*

CLAUSE	PAGE
1. Scope .....	1
2. References .....	1
3. Definitions.....	4
4. Functional characteristics.....	12
4.1 Typical equipment functional diagrams.....	12
4.2 System functional characteristics.....	14
5. Interfaces .....	22
5.1 Mechanical .....	23
5.2 Grounding .....	24
5.3 Electrical power .....	24
5.4 Data and control interfaces .....	25
5.5 Communication .....	30
5.6 User interface (UI) .....	33
6. Environmental conditions .....	35
6.1 Environment.....	35
6.2 Vibration and shock .....	37
6.3 Seismic environment.....	38
6.4 Lightning and switching surge protection.....	38
6.5 Acoustic interference limitations .....	39
6.6 Electromagnetic interference (EMI) and electromagnetic compatibility (EMC) .....	39
7. Characteristics.....	40
7.1 Reliability.....	40
7.2 Maintainability .....	41
7.3 Availability.....	42
7.4 System security .....	43
7.5 Expandability .....	45
7.6 Changeability .....	45
7.7 Spare capacity .....	46
8. Marking .....	47
8.1 Identification .....	47
8.2 Nameplates.....	47
8.3 Warning.....	47
9. Tests and inspections .....	47
9.1 Stages of tests and inspections .....	48
9.2 Interface tests and inspections.....	48
9.3 Environmental tests.....	51
9.4 Functional tests .....	52
9.5 System performance tests.....	53

CLAUSE	PAGE
9.6 Stability test.....	56
9.7 Availability test.....	56
9.8 Maintainability test .....	56
9.9 Expandability tests .....	57
9.10 Documentation verification.....	57
10. Documentation .....	57
10.1 Design .....	58
10.2 Installation.....	58
10.3 Operating instructions and records .....	58
10.4 Maintenance instructions and records.....	59
10.5 Test.....	59
Annex A (informative) Master station/RTU interconnections .....	60
Annex B (informative) Channel loading calculation .....	64
Annex C (informative) Bibliography .....	67

# IEEE Standard Definition, Specification, and Analysis of Systems Used for Supervisory Control, Data Acquisition, and Automatic Control

## 1. Scope

This standard applies to, and provides the basis for, the definition, specification, performance analysis, and application of systems used for supervisory control; data acquisition or automatic control, or both, in attended or unattended electric substations, including those associated with generating stations; and power utilization and conversion facilities. Systems covered by this standard typically use processors in the master station and in the remote stations. Such processors provide facilities for incorporating automatic control functions, either by the supplier or by the user, after the system is installed.

This standard does not apply to electromechanical or static, protective-relaying equipment (see IEEE Std C37.90-1989 , IEEE Std C37.90.1-1989 , IEEE Std C37.90.2-1987 , IEEE Std C37.91-1985 , IEEE Std C37.93-1987 , IEEE Std C37.95-1989 , IEEE Std C37.96-1988 , and IEEE Std C37.97-1979 ).<sup>1</sup>

## 2. References

This standard shall be used in conjunction with the following publications. The version of the standards shown below was used in this revision of this document. When the following standards are superseded by an approved revision, the revision shall apply.

ANSI S1.4-1983, Specification for Sound Level Meters.<sup>2</sup>

ANSI S12.10-1985, (R1990) Methods for the Measurement and Designation of Noise Emitted by Computer and Business Equipment.

---

<sup>1</sup>Information on references can be found in clause 2..

<sup>2</sup>ANSI publications are available from the Sales Department, American National Standards Institute, 11 West 42nd Street, 13th Floor, New York, NY 10036, USA.

ANSI X3-TR-1-1983, American National Standard Dictionary for Information Processing.

ANSI X3.1-1987 (R1992), Information Systems—Data Transmission—Synchronous Signaling Rates.

ANSI X3.4-1986 (R1992), Coded Character Set—7-Bit American National Standard Code for Information Interchange.

ANSI Y14.15-1966 (R1988), Electrical and Electronics Diagrams (includes Supplements ANSI Y14-15a-1971 and ANSI Y14.15b-1973).

ANSI Z24.21-1957 (R1989), Method for Specifying the Characteristics of Pickups for Shock and Vibration Measurement.

ANSI/EIA 310-D-1992, Racks, Panels, and Associated Equipment.

ANSI/EIA 334-A-1985, Signal Quality at Interface Between Data Terminal Equipment and Synchronous Data Circuit-Terminating Equipment for Serial Data Transmission.

ANSI/EIA 404-1985, Start-Stop Signal Quality Between Data For Nonsynchronous Data Terminal Equipment.

ANSI/ISO 5807-1985, Information Processing—Documentation Symbols and Conventions for Data, Program and Systems Flowcharts, Program Network Charts, and System Resource Charts (revision and redesignation of ANSI X3.5-1970).

ANSI/NFPA 70-1993, the National Electric Code (NEC) Handbook.

EIA IEB 12-1977, Application Notes on Interconnection Between Interface Circuits Using RS-449 and RS-3232-C.<sup>3</sup>

EIA TIA-232-E-1991, Interface Between Data Terminal Equipment and Data Circuit-Terminating Equipment Employing Serial Binary Data Interchange.

EIA 363-1969, Specifying Signal Quality for Transmitting and Receiving Data Processing Terminal Equipments Using Serial Data Transmission at the Interface with Non-Synchronous Data Communication Equipment.

EIA 423-A-1978, Electrical Characteristics of Unbalanced Voltage Digital Interface Circuits.

EIA TIA-530-A-1992, High Speed 25-Position Interface for Data Terminal Equipment and Data Circuit-Terminating Equipment, Including Alternative 26-Position Connector (Replaces EIA-449 and EIA-449-1).

IEC 654-3 (1983), Operating Conditions for Industrial Process Measurement and Control Equipment.<sup>4</sup>

IEEE Std 91-1984, IEEE Standard Graphic Symbols for Logic Functions (ANSI).<sup>5</sup>

IEEE Std 91a-1991, Supplement to IEEE Standard Graphic Symbols for Logic Functions (ANSI).

IEEE Std 100-1992, The New IEEE Standard Dictionary of Electrical and Electronics Terms (ANSI).

---

<sup>3</sup>EIA publications are available from Global Engineering, 1990 M Street NW, Suite 400, Washington, DC, 20036, USA.

<sup>4</sup>IEC publications are available from IEC Sales Department, Case Postale 131, 3 rue de Varembe, CH-1211, Genève 20, Switzerland/Suisse. IEC publications are also available in the United States from the Sales Department, American National Standards Institute, 11 West 42nd Street, 13th Floor, New York, NY 10036, USA.

<sup>5</sup>IEEE publications are available from the Institute of Electrical and Electronics Engineers, 445 Hoes Lane, P.O. Box 1331, Piscataway, NJ 08855-1331, USA.

IEEE Std 200-1975 (Reaff 1988), IEEE Standard Reference Designations for Electrical and Electronics Parts and Equipment (ANSI).

IEEE Std 280-1985 (Reaff 1991), IEEE Standard Letter Symbols for Quantities Used in Electrical Science and Electrical Engineering (ANSI).

IEEE Std 315-1975 (Reaff 1989), IEEE Standard Graphic Symbols for Electrical and Electronics Diagrams (ANSI).

IEEE Std 315A-1986, IEEE Standard Graphic Symbols for Electrical and Electronics Diagrams (Supplement to IEEE Std 315-1975) (ANSI).

IEEE Std 344-1987, IEEE Recommended Practice for Seismic Qualification of Class 1E Equipment for Nuclear Power Generating Stations (ANSI).

IEEE Std 422-1986, IEEE Guide for the Design and Installation of Cable Systems in Power Generating Stations (ANSI).

IEEE Std 525-1992, IEEE Guide for the Design and Installation of Cable Systems in Substations (ANSI).

IEEE Std 999-1992, IEEE Recommended Practice for Master/Remote Supervisory Control and Data Acquisition (SCADA) Communications (ANSI).

IEEE Std C37.2-1991, IEEE Standard Electrical Power System Device Function Numbers.

IEEE Std C37.90-1989, IEEE Standard for Relays and Relay Systems Associated with Electric Power Apparatus (ANSI).

IEEE Std C37.90.1-1989 (Reaff 1991), IEEE Standard Surge Withstand Capability (SWC) Tests for Protective Relays and Relay Systems (ANSI).

IEEE Std C37.90.2-1987, IEEE Trial-Use Standard Withstand Capability of Relay Systems to Radiated Electromagnetic Interference from Transceivers (ANSI).

IEEE Std C37.91-1985 (Reaff 1991), IEEE Guide for Protective Relay Applications to Power Transformers (ANSI).

IEEE Std C37.93-1987, IEEE Guide for Power System Protective Relay Applications of Audio Tones over Telephone Channels (ANSI).

IEEE Std C37.95-1989, IEEE Guide for Protective Relaying of Utility-Consumer Interconnections (ANSI).

IEEE Std C37.96-1988, IEEE Guide for AC Motor Protection (ANSI).

IEEE Std C37.97-1979 (Reaff 1990), IEEE Guide for Protective Relay Applications to Power System Buses (ANSI).

IEEE Std C37.98-1987 (Reaff 1991), IEEE Standard for Seismic Testing of Relays (ANSI).

IEEE Std C37.100-1992, IEEE Standard Definitions for Power Switchgear (ANSI).

MIL-H-DBK 217D-1991 (Change Notice 1992), Reliability Prediction of Electronic Equipment.<sup>6</sup>

MIL-STD 471A-1978 (Interim Notice No. 2 1978), Maintainability Demonstration.

---

<sup>6</sup>MIL publications are available from the Director, U.S. Navy Publications and Printing Service, Eastern Division, 700 Robbins Avenue, Philadelphia, PA 19111, USA.

MIL-STD 1472D-1989 (Change Notice 1992), Human Engineering Design Criteria for Military System Equipment and Facilities.

NEMA 250-1991, Enclosures for Electrical Equipment (1000 Volts Maximum) (ANSI).<sup>7</sup>

### 3. Definitions

The definitions of terms contained in this standard are not intended to embrace all legitimate meanings of the terms. They are applicable only to the subject treated in this standard.

Supervisory control and data acquisition systems use computers. For standard definitions of computer terms refer to ANSI X3-TR-1-1983.

Definitions from IEEE Std 100-1992 are indicated with an asterisk (\*) following the definition.

**3.1 accumulator point interfaces:** Master station or RTU (or both) element(s) that accept(s) a pulsing digital input signal to accumulate a total of pulse counts.

**3.2 accumulator SCADA function:** The capability of a supervisory system to accept and totalize digital pulses and make them available for display or recording, or both.

**3.3 alarm condition:** A predefined change in the state or condition of equipment or the failure of equipment to respond correctly. Indication may be audible or visual, or both.\*

**3.4 alarm point interfaces:** Master station or RTU (or both) element(s) that input(s) a signal to the alarm function.

**3.5 alarm SCADA function:** The capability of a supervisory system to accomplish a predefined action in response to an alarm condition. *See also:* 3.3, **alarm condition**.

**3.6 analog device:** A device that operates with variables represented by continuously measured quantities such as voltages, resistances, rotations and pressures.\*

**3.7 analog function check:** Monitor a reference quantity. A check of master and remote station equipment by exercising a predefined component or capability.

**3.8 analog point interfaces:** Master station or RTU (or both) element(s) that input(s) or output(s) an analog quantity.

**3.9 analog quantity:** A variable represented by a scalar value (see 4.2.3. 1).\*

**3.10 analog SCADA function:** The capability of a supervisory system to accept, record, or display, or do all of these, an analog quantity as presented by a transducer or external device. The transducer may or may not be a part of the supervisory control system.

**3.11 analog telemetering:** Telemetering in which some characteristic of the transmitter signal is proportional to the quantity being measured.\*

**3.12 analog-to-digital (A/D) conversion:** Production of a digital signal whose magnitude is proportional to the value of an analog quantity.\*

**3.13 automatic:** Pertaining to a process or device that, under specified conditions, functions without intervention by a human operator.\*

**3.14 automatic control:** An arrangement of electrical controls that provides for switching or controlling, or both, of equipment in an automatic sequence and under predetermined conditions.\*

**3.15 availability:** The ratio of uptime to total time (uptime plus downtime)\* (see 7.3).

---

<sup>7</sup>NEMA publications are available from the National Electrical Manufacturers Association, 2101 L Street NW, Washington, DC 20037, USA.

**3.16 backup:** Provision for an alternate means of operation if the primary system is not available.\*

**3.17 backup, degraded:** A backup capability that does not perform all of the functions of the primary system.\*

**3.18 baud:** The signaling speed, that is, keying rate of the modem. The signaling speed in baud is equal to the reciprocal of the shortest element duration in seconds to be transmitted. The terms “bit rate” and “baud” are not synonymous and shall not be interchanged in usage. Preferred usage is bit rate, with baud used only when the details of a communication modem or channel are specified.

For example, in the following table, the signaling speed is calculated from the signaling element duration. In addition, the distinction between bit rate and baud for two different types of modems is illustrated.\*

	Signaling technique	
	Modem one	Modem two
Signaling element duration	0.833 ms	
Signaling speed	1200 baud	
Information transmitted per element duration	1 b	2 b
Bit rate	1200 b/s	2400 b/s

**3.19 bit rate:** The number of bits transferred in a given time interval. Bits per second is a measure of the rate at which bits are transmitted.\*

**3.20 buffer:** A device in which data are stored temporarily, in the course of transmission from one point to another; used to compensate for a difference in the flow of data, or time of occurrence of events, when transmitting data from one device to another.\*

**3.21 burn-in:** A period, prior to on-line operation, during which equipment is continuously energized for the purpose of forcing infant-mortality failures.\*

**3.22 calibration:** Adjustment of a device so that the output is within a specific range for particular values of the input.\*

**3.23 certified design test:** A test performed on a production model specimen of a generic type of equipment to establish a specific performance parameter of that genre of equipment. The condition and results of the test are described in a document that is signed and attested to by the testing engineer and other appropriate, responsible individuals.\*

**3.24 channel load factor:** The fraction of channel operating time used to transfer the required volume of information between its terminals (see 5.5.1.4 and annex B).

**3.25 channel, SCADA:** The communication path between master station and RTUs\* (see figure 1).

**3.26 closed loop control:** A type of automatic control in which control actions are based on signals fed back from the controlled equipment or system.\* For example, RTUs can manage local voltage conditions by control of load tap changers and volt amperes reactive (VAR) control compensation equipment.

**3.27 common mode interference:** See: 3.74, **interference, common mode.**

**3.28 console:** That component of the system that provides facilities for observation and control of the system (e.g., operator’s console, maintenance console).\*

**3.29 contention:** An operational condition in which two or more devices simultaneously try to use the same resource (e.g., communication channel, disk, memory).\*

**3.30 continuous update supervisory system:** A system in which the RTU continuously updates indication and telemetering to the master station, regardless of action taken by the master station. The RTU may interrupt the continuous data updating to perform a control operation.\*

**3.31 control function check:** Control and indication from a control-check relay. A check of master and remote station equipment by exercising a predefined component or capability.

**3.32 control panel:** *See:* 3.91, **panel, control.**

**3.33 control point interfaces:** Master station or RTU (or both) element(s) that operate(s) to perform a control function.

**3.34 control SCADA function:** The capability of a supervisory system to selectively perform manual or automatic, or both, operation (singularly or in selected groups) of external devices. Control may be either analog (magnitude or duration) or digital.

**3.35 current-type telemeter:** A telemeter that employs the magnitude of a single current as the translating means.\*

**3.36 data:** Any representation of a digital or analog quantity to which meaning has been assigned.\*

**3.37 data acquisition:** The collection of data.\*

**3.38 data acquisition system:** A system that receives data from one or more locations.\*

**3.39 data logging:** The recording of selected data on suitable media.\*

**3.40 data rate:** The rate at which a data path (e.g., channel) carries data, measured in bits per second (b/s).\*

**3.41 data test:** a) The recorded results of test.

b) A set of data developed specifically to test the adequacy of a computer run or system. They may be actual data taken from previous operations or artificial data created for this purpose.

**3.42 deadband:** The range through which an analog quantity can vary without initiating response.\*

**3.43 degraded backup:** *See:* 3.17, **backup, degraded.**

**3.44 device (electrical equipment):** An operating element (e.g., relay, contactor, circuit breaker, switch, valve, or governor) used to perform a given function in the operation of electrical equipment.\*

**3.45 diagnostics, self:** Programs automatically executed, at predetermined intervals, in the master station or RTU, to check the health of the system.

**3.46 differential mode interference:** *See:* 3.75, **interference, differential mode.**

**3.47 digital quantity:** A variable represented by a number of bits.\*

**3.48 digital telemetering:** Telemetering in which a numerical representation is generated and transmitted; the number being representative of the quantity being measured.\*

**3.49 digital-to-analog (D/A) conversion:** Production of an analog signal whose magnitude is proportional to the value of a digital quantity.\*

**3.50 disable:** A command or condition that prohibits some specific event from occurring.\*

**3.51 display, graphic:** A hardware device (e.g., CRT, VDT, liquid crystal display (LCD), mapboard, plasma panel, arrays of lamps, or light-emitting diodes) used to visually present information.\*

**3.52 distributed processing:** A design in which data is processed by more than one processor.\*

**3.53 downtime:** The time during which a device or system is not capable of meeting its functional requirements\* (see 7.3).

**3.54 echo checkback message:** A communication technique assuring that a message received at the termination point in a system is the same message as originally transmitted. The received message is retransmitted to the sending device and matched to ensure that the original message was received properly.\*

**3.55 electromagnetic compatibility (EMC):** A measure of equipment tolerance to external electromagnetic fields\* (see 6.6.2).

**3.56 electromagnetic interference (EMI):** A measure of electromagnetic radiation from equipment\* (see 6.6.1).

**3.57 enable:** A command or condition that permits some specific event to occur.\*

**3.58 engineering unit:** A unit of physical measurement (e.g., volts, amperes).\*

**3.59 event:** A discrete change of state (status) of a system or device.\*

**3.60 expendability:** The capability of a system to be increased in capacity or provided with additional functions\* (see 7.5).

**3.61 failover:** The transfer of a function or functions to a backup device.

**3.62 failure:** An event that limits the capability of equipment or a system to perform its function(s)\* (see 7.1).

**3.63 failure distribution:** The manner in which failures occur as a function of time; generally expressed in the form of a curve with the abscissa being time.\*

**3.64 frequency-type telemeter:** A telemeter that employs the frequency of a periodically recurring electric signal as the translating means.\*

**3.65 graphic display:** See: 3.51, **display, graphic.**\*

**3.66 hardcopy:** A paper record of information (e.g., reports, listings, logs, and charts).\*

**3.67 infant mortality failures:** A characteristic pattern of failure wherein the number of failures per unit of time decreases rapidly as the number of operating hours increase.\*

**3.68 I/O:** Input/output points.

**3.69 indication:** An audio or visual signal that signifies a particular condition.\*

**3.70 indication (status) function:** The capability of a supervisory system to accept, record, or display, or do all of these, the status of a device. The status of a device may be derived from one or more inputs giving the following two or more states of indication:

- a) *Two-state indication.* Only one of the two possible positions of the supervised device is displayed at one time. Such display may be derived from a single set of contacts.
- b) *Three-state indication.* One in which the transitional state or security indication as well as the terminal positions of the supervised device is displayed. Such a display is derived from at least two sets of initiating contacts.
- c) *Multistate indication.* Only one of the predefined states (transitional or discrete, or both) is indicated at a time. Such a display is derived from multiple inputs.
- d) *Indication with memory.* An indication function with the additional capability of storing single or multiple changes of status that occur between scans.

**3.71 indication (status) point interfaces:** Master Station or RTU (or both) element(s) that accept(s) a digital input signal for the function of indication.

The input/output elements of a SCADA system provide the physical interface to external devices. It is preferred that a point serve one of the functions described below. In some earlier applications, a Control and Indication (C and I) point has been used to specify a combination control and indication point for a specific device (e.g., circuit breaker). The functions are:

- a) *Two-state indication.* Only one of the two possible positions of the supervised device is displayed at one time. Such display may be derived from a single set of contacts.
- b) *Three-state indication.* One in which the transitional state or security indication as well as the terminal positions of the supervised device is displayed. Such a display is derived from at least two sets of initiating contacts.
- c) *Multistate indication.* Only one of the predefined states (transitional or discrete, or both) is indicated at a time. Such a display is derived from multiple inputs.

- d) *Indication with memory*. An indication function with the additional capability of storing single or multiple changes of status that occur between scans.

**3.72 inhibit:** To prevent a specific event from occurring (e.g., alarm inhibit).\*

**3.73 intelligent electronic device IED):** Any device incorporating one or more processors with the capability to receive or send data/control from or to an external source (e.g., electronic multifunction meters, digital relays, controllers).

**3.74 interference, common mode:** a) Interference that appears between both signal leads and a common reference plane (ground) and causes the potential of both sides of the transmission path to be changed simultaneously and by the same amount relative to the common reference plane (ground).\*

b) A form of interference that appears between any measuring circuit terminal and ground.\*

**3.75 interference, differential mode:** Interference that causes the potential of one side of the signal transmission path to be changed relative to the other side.\*

**3.76 interference, normal mode:** A form of interference that appears between measuring circuit terminals.\* *See also:* 3.75, **interference, differential mode**.

**3.77 interposing relay:** *See:* 3.106, **relay, interposing**.

**3.78 local area network (LAN):** A communication network to interconnect a variety of intelligent devices (e.g., personal computers, workstations, printers, file storage devices) that can transmit data over a limited area, typically within a facility.

**3.79 logging function check:** Accomplished when results of the control function check are logged. A check of master and remote station equipment by exercising a predefined component or capability (see 7.4.1).

**3.80 log:** A printed record of data.\*

**3.81 manual control:** Control in which the system or main device, whether direct or power-aided in operation, is directly controlled by an operator.\*

**3.82 master station:** *See:* 3.129, **station, master**.

**3.83 master terminal unit (MTU):** Refers to the master station of a supervisory control system.\*

**3.84 mean time between failure (MTBF):** The time interval (hours) that may be expected between failures of an operating equipment (see 7.1).\*

**3.85 mean time to repair (MTTR):** The time interval (hours) that may be expected to return a failed equipment to proper operation (see 7.2).\*

**3.86 modem:** A MODulator/DEMODulator device, which converts serial binary digital data to and from the signal form appropriate for the respective communication channel.\*

**3.87 multibit point interface:** Multibit (e.g., BCD, gray code) point. Master Station or RTU (or both) element(s) that inputs a series of multibit quantities in parallel.

**3.88 normal mode:** *See:* 3.76, **interference, normal mode/**

**3.89 offset:** A predetermined value modifying the actual value (e.g., the use of a 4 mA signal to represent zero in a 4 mA to 20 mA system).\*

**3.90 open loop control:** A form of control without feedback.\*

**3.91 panel, control:** An assembly of user interface devices (see 5.6).\*

**3.92 partial automatic control:** Control that is a combination of manual and automatic control.\* For example, to cause a voltage reduction, the local automatic load tap changing closed-loop control may be biased by way of a supervisory control command.

**3.93 point test:** A predefined location within equipment or routines at which a known result should be present if the equipment or routine is operating properly.

**3.94 poll function check:** Accomplished when analog function is performed with all remotes. A check of master and remote station equipment by exercising a predefined component or capability. *See also:* 3.7, **analog function check.**

**3.95 polling (data request):** The process by which a data acquisition system selectively requests data from one or more of its RTUs. An RTU may be requested to respond with all, or a selected portion of, the data available.\*

**3.96 polling supervisory system:** A system in which the master station periodically interrogates each RTU to request data.\*

**3.97 primary:** An equipment or subsystem that is normally on-line and performing system functions. *See also:* 3.16, **backup.**\*

**3.98 processor:** A system or mechanism that accepts a program as input, prepares it for execution, and executes the process so defined with data to produce results.\*

**3.99 programmable equipment:** An RTU or master station having one or more of its operations specified by a program contained in a memory device.\*

**3.100 protocol:** A strict procedure required to initiate and maintain communication.\*

**3.101 pulse-type telemeter:** A telemeter that employs characteristics of intermittent electric signals, other than their frequency, as the translating means.\*

**3.102 quiescent supervisory system:** A system that is normally alert but inactive. It transmits information only when a change in indication occurs at the RTU or when a command operation is initiated at the master station.\*

**3.103 random failures:** The pattern of failures for equipment that has passed out of its infant-mortality period and has not reached the wear-out phase of its operating lifetime. The reliability of an equipment in this period may be computed by the equation:

$$R = e^{-\lambda t} \quad (1)$$

where

$\lambda$  is failure rate  
 $t$  is time period of interest

**3.104 ratio-type telemeter:** A telemeter that employs the relative phase position between, or the magnitude relation between, two or more electrical quantities as the translating means. Examples of ratio-type telemeters include ac or dc position matching systems.\*

**3.105 re-encoded checkback message:** Message from the initiating end that is re-encoded by the receiving end. A new message is sent to the initiating end to verify error-free receipt and proper interpretation of the message. In typical applications the initiating end is the master station and the receiving end is the RTU. Preferred usage is re-encoded, which allows the master station to verify not only that the communication was error free, but also that the RTU's I/O hardware and software acted correctly in interpreting the selection (see 7.4).

**3.106 relay, interposing:** A device that enables the energy in a high-power circuit to be switched by a low-power control signal, provides isolation, and/or provides contact multiplication.\*

**3.107 remote control:** Control of a device from a distant point.\*

**3.108 remote station:** *See:* 3.130, **station, remote.**

**3.109 remote terminal unit:** *See:* 3.130, **station, remote.**

**3.110 report-by-exception:** The reporting of data (e.g., from RTU to master station) only when the data either changes state (e.g., for a status or digital input point) or exceeds a predefined deadband (e.g., for an analog input point).

**3.111 resolution:** The least value of the measured quantity that can be distinguished.\*

- 3.112 response time:** The time between initiating some operation and obtaining results. \*
- 3.113 RTU:** *See:* 3.130, **station, remote.**
- 3.114 SCADA:** *See:* 3.136, **supervisory control and data acquisition.**
- 3.115 SCADA channel:** *See:* 3.25, **channel, SCADA.**
- 3.116 scan function check:** Accomplished when control function check has been performed with all remotes. A check of master and remote station equipment by exercising a predefined component or capability.
- 3.117 scan (interrogation):** The process by which a data acquisition system interrogates RTUs for points of data. \* *See also:* 3.95, **polling (data request).**
- 3.118 scan cycle:** The time in seconds required to obtain a collection of data (e.g., all data from one RTU, all data from all RTUs, or all data of a particular type from all RTUs).\*
- 3.119 scanning supervisory system:** A system in which the master station controls all information exchange. The normal state is usually one of repetitive communication with the RTUs.\*
- 3.120 self-diagnostics:** *See:* 3.45, **diagnostics, self.**
- 3.121 semi-automatic station:** *See:* 3.131, **station, semi-automatic.**
- 3.122 sequence-of-events (SOE):** Digital input points that are time tagged to include relative or absolute time of occurrence.
- 3.123 sequence-of-events point interface:** Master station or RTU (or both) element(s) that accept(s) a digital input signal to perform the function of time tagging the occurrence of an event. *See also:* 3.122, **sequence-of-events (SOE).**
- 3.124 sequence-of-events SCADA function:** The capability of a supervisory system to recognize each predefined event, associate a time of occurrence with each event, and present the event data in order of occurrence of the events.
- 3.125 serial communication:** A method of transmitting information between devices by sending all bits serially over a single communication channel.\*
- 3.126 settling time:** Time required by channel or terminal equipment to reach an acceptable operating condition.
- 3.127 spare only point interface:** Point for which cabinet space only is provided for the future addition of wiring and other necessary plug-in equipment.
- 3.128 spare point interface:** Point equipment that is not being utilized but is fully wired and equipped.
- 3.129 station, master:** The entire complement of devices, functional modules, and assemblies that are electrically interconnected to affect the master station supervisory functions. The equipment includes the interface with the communication channel but does not include the interconnecting channel. During communication with one or more remote stations, the master station is the superior in the communication hierarchy.\*
- 3.130 station, remote:** The entire complement of devices, functional modules, and assemblies that are electrically interconnected to affect the remote station supervisory functions. The equipment includes the interface with the communication channel but does not include the interconnecting channel. During communication with a master station the remote station is the subordinate in the communication hierarchy.
- 3.131 station, semiautomatic:** A station that requires both automatic and manual modes to maintain the required character of service.\*
- 3.132 station, sub-master:** A station that can perform as a master station on one message transaction and as a remote station on another message transaction.

**NOTES:**

Examples of station equipments include

- 1- *Hardwired.* Station supervisory equipment that is comprised entirely of wired-logic elements.

- 2- *Firmware.* Station supervisory equipment that uses hardware logic programmed routines in a manner similar to a computer. The routines can only be modified by physically exchanging logic memory elements.
- 3- *Programmable.* Station supervisory equipment that uses software routines.

**3.133 status:** Information describing a logical state of a point or equipment. \*

**3.134 sub-master station:** *See:* 3.132, **station, sub-master.**

**3.135 supervisory control:** An arrangement for operator control and supervision of remotely located apparatus using multiplexing techniques over a relatively small number of interconnecting channels. \*

**3.136 supervisory control and data acquisition (SCADA):** A system operating with coded signals over communication channels so as to provide control of RTU equipment. The supervisory system may be combined with a data acquisition system by adding the use of coded signals over communication channels to acquire information about the status of the RTU equipment for display or for recording functions. \*

**3.137 supervisory system:** All control, indication, and associated telemetering equipment at the master station, and all of the complementary devices at the RTU(s). \*

**3.138 system time:** A coordinated value of time maintained throughout the control and data acquisition equipment.

**3.139 tag:** A visual indication, typically at the master station, to indicate a special condition associated with a device (e.g., unavailable for control). \*

**3.140 telemetering selection point interface:** Master station or RTU (or both) element(s) for the selective connection of telemetering transmitting equipment to appropriate telemetering receiving equipment over an interconnecting communication channel. This type of point is more commonly used in electromechanical or stand-alone type of supervisory control.

**3.141 timer, watchdog:** A form of interval timer that is used to detect a possible malfunction. \*

**3.142 transaction:** That sequence of messages between master and remote stations required to perform a specific function (e.g., acquire specific data or control a selected device). \*

**3.143 transverse (differential) mode:** *See:* 3.75, **interference, differential mode.**

**3.144 troubleshoot:** Action taken by operating or maintenance personnel, or both, to isolate a malfunctioned component of a system. Actions may be supported by printed procedures, diagnostic circuits, test points, and diagnostic routines. \*

**3.145 uninterruptible power supply (UPS):** A system designed to automatically provide power, without delay or transients, during any period when the normal power supply is incapable of performing acceptably. \*

**3.146 uptime:** The time during which a device or system is capable of meeting functional requirements\* (see 7.3).

**3.147 user interface (UI):** A physical interface between the operator and the system equipment.

**3.148 video display terminal (VDT):** The visual equipment used as a user interface. *See also:* 3.147, *user interface (UI).*

**3.149 voltage-type telemeter:** A telemeter that employs the magnitude of a single voltage as the translating means. \*

**3.150 watchdog timer:** *See:* 3.141, **timer, watchdog.**

**3.151 wear-out failures:** The pattern of failures experienced when equipment reaches its period of deterioration. Wear-out failure profiles may be approximated by a Gaussian (bell curve) distribution centered on the nominal life of the equipment. \*

**3.152 wired point interface:** Point for which all common equipment, wiring, and space are provided. To activate the point requires only the addition of plug-in hardware for the specific point.

## 4. Functional characteristics

The control and data acquisition equipment governed by this standard may be arranged in various configurations, and may perform some or all of the functions identified in this clause.

Typically, control and data acquisition equipment compose a system with at least one master station and one or more remote terminal units (RTUs). Figure 1 illustrates the possible data and control flow between a master station and one or more RTUs.

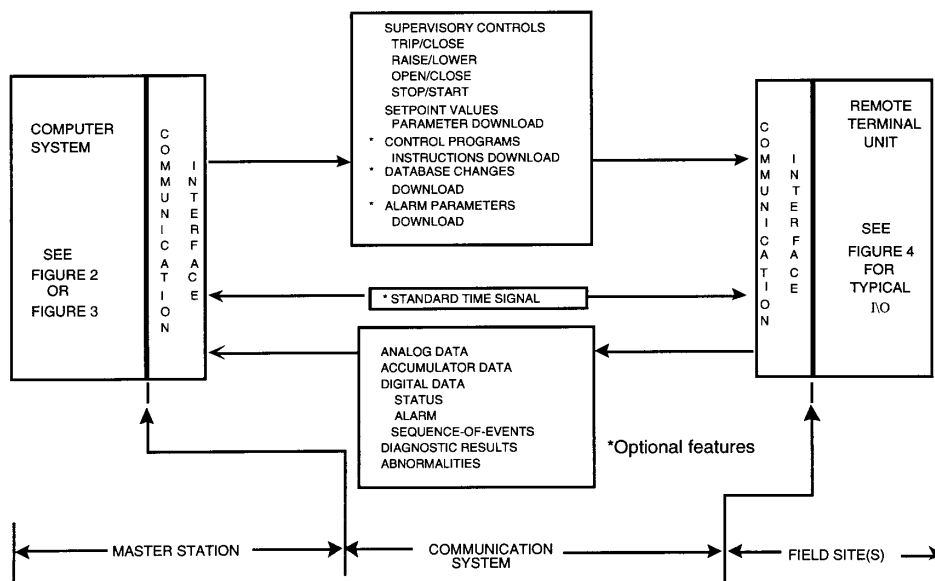

Figure 1— Master/RTU functional data/control flow

### 4.1 Typical equipment functional diagrams

Functional diagrams of typical RTU and master station equipment and configurations are illustrated within this subclause.

The links between the master station(s) and RTUs, and between the sub-master RTU and its slave RTUs, can be any suitable communication media. The communication protocol typically used requires a master station to initiate message transactions. In some cases the RTU can initiate the communication messages. For additional communications protocol information, see IEEE Std 999-1992.

The functional components of a master station are illustrated in figures 2 and 3. A dual computer master station is illustrated in figure 2, however, a single computer master station may be adequate for some applications.

A distributed multi-computer master station is illustrated in figure 3. Multiple master stations may perform different functions from another, i.e., one dedicated to Supervisory Control and Data Acquisition (SCADA) functions and another dedicated to sequence-of-events or fault analysis. Also, each computer in a distributed master station may typically be assigned to a specialized processing task separate and distinct from the others; i.e., one dedicated to SCADA, one or more to other application processing, etc. Application processing may include features like trend analysis, load profiling/forecasting, etc. The computer illustrated in figures 2 and 3 as a single box typically includes mass memory and various peripherals. The communication interface portion of figures 2 and 3 are used to interface the RTU communication channels to the master station computer system. The user interface (UI) portion is used to present information to, and accept inputs from, the user(s).

The functional components of an RTU are illustrated in figure 4. Various interconnections of master station(s) and RTU(s) are illustrated in annex A.

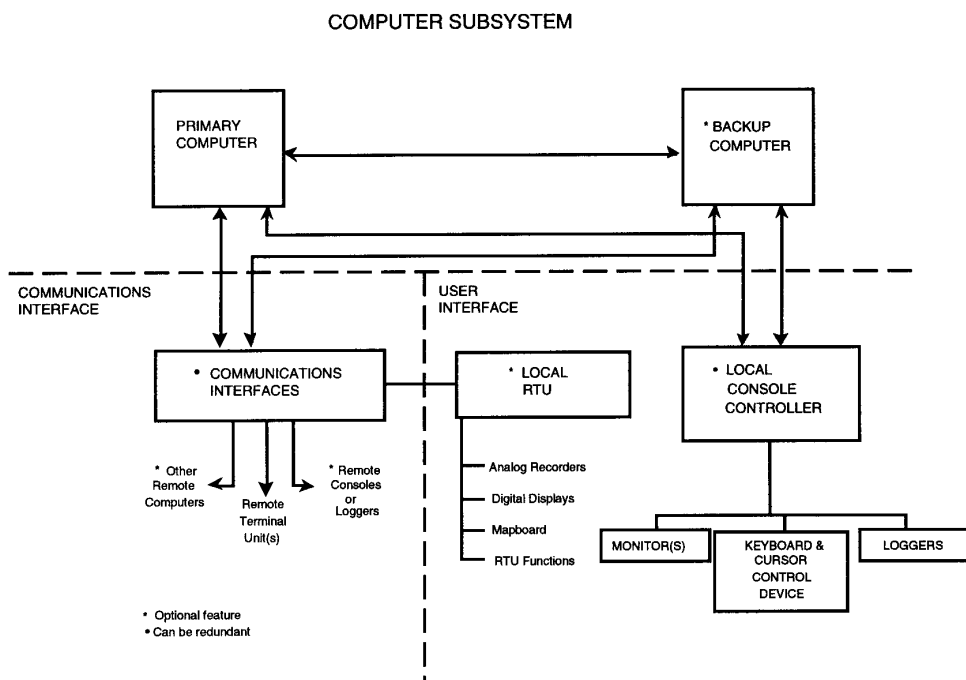

Figure 2— Master station functional block diagram (centralized functions)

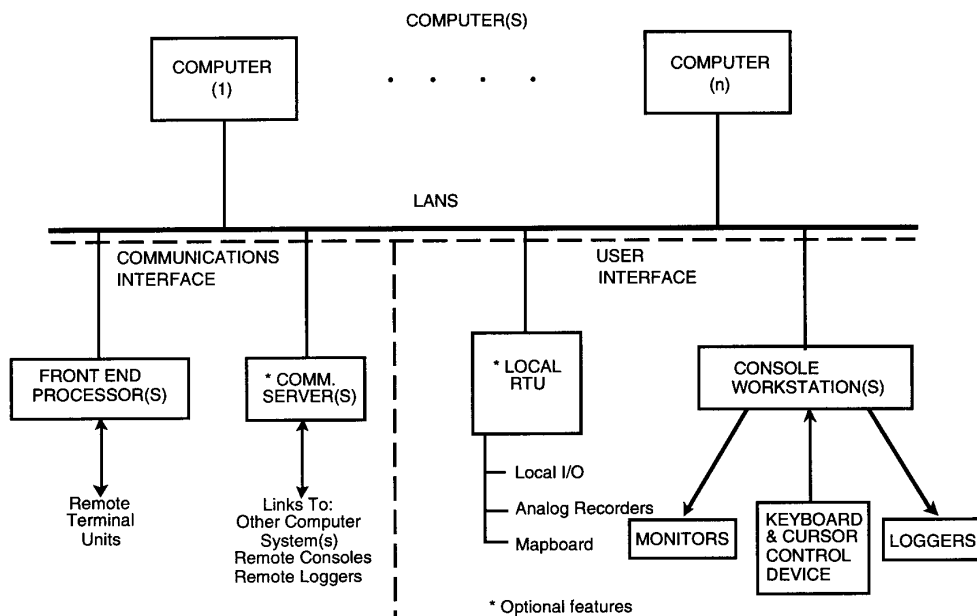

Figure 3— Master station functional block diagram (distributed functions)

## 4.2 System functional characteristics

This subclause provides guidance for helping both users and suppliers jointly define the functional capabilities that may be in a system.

Each generic function is described in terms of the minimum features or characteristics that shall be addressed to adequately define the function.

The subclauses that follow shall be used as a checklist to help ensure adequate communication between the user and the supplier of control and data acquisition equipment.

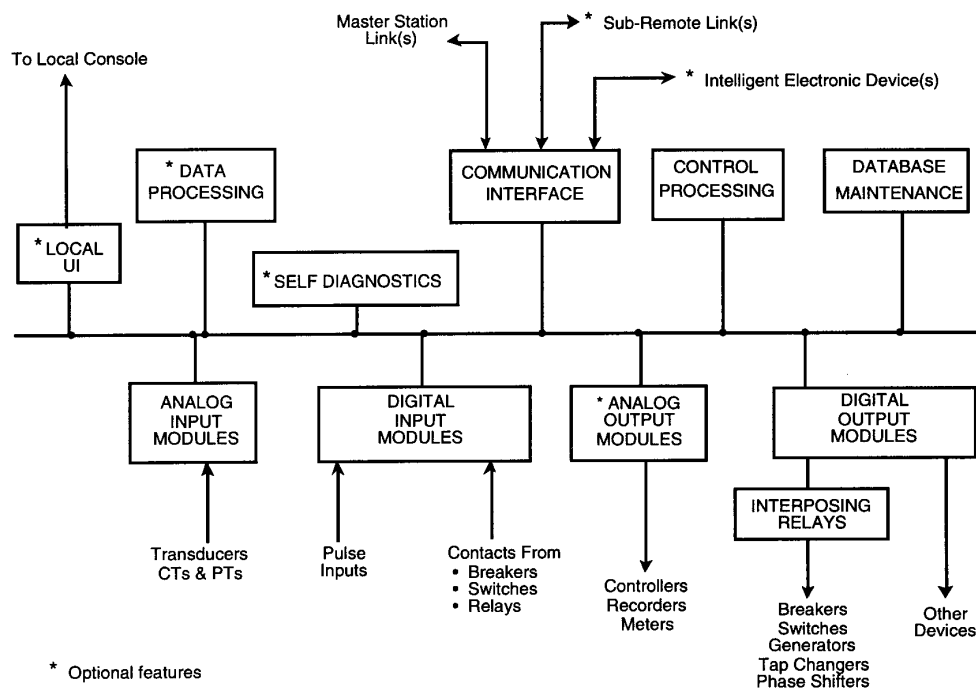

**Figure 4— Remote terminal unit functional block diagram**

When the feature or characteristic is fixed by the design of the equipment, the burden of definition rests on the supplier (e.g., number of inputs/outputs per card). However, variable features (e.g., scaling resistors, switch settings, and software) shall be jointly defined by the user and the supplier.

### 4.2.1 Communication management

The requirements to communicate between the master station(s) and the RTUs shall be well defined. See IEEE Std 999-1992 for an example of the definition of a communication protocol. The topics to be defined include

- a) Message protocol
- b) Number of channels
- c) Channel considerations (see 5.5.1.4)
- d) Error detection techniques
- e) Channel switching
- f) Number of RTUs per channel and/or channels per RTU
- g) Number of retries each attempt
- h) Time out value(s) by message type

- i) Communication error reporting, failure criteria, and recovery
- j) Channel quality monitoring (normal and backup)
- k) Channel diagnostic/test provisions
- l) Equipment interfaces
- m) Report-by-exception polling or point scan

#### 4.2.2 Data acquisition

The characteristics for each data type shall be defined. Ranges of data input, scale factors, rates, and accuracy shall be defined for the data types to be supported such as

- a) Analog inputs
- b) Status inputs—two state
- c) Status inputs—more than two state (more than two state status inputs are usually accomplished by using multiple two state status inputs)
- d) Status inputs—with memory
- e) Accumulator pulse inputs
- f) Sequence-of-events inputs
- g) BCD inputs—multi-bit

The data acquisition capability for each data type shall be defined in terms of the following characteristics:

- a) *Scan groups*. Number of scan groups, size of each group, points in each group.
- b) *Scan cycle*. Time to complete the acquisition of a scan group from all remotes on the communication channel. The communication hardware related performance capabilities used in the calculation of scan cycle shall be defined.

##### 4.2.2.1 RTU data

The capacity (total inputs) and rate of acquisition (inputs per second) for field data interfaced to the RTU equipment shall be defined for all applicable data types (see 5.4).

The modularity (e.g., number of inputs per card) of each data type shall also be specified.

##### 4.2.2.2 Master station data

The capacity (total inputs) and rate of acquisition (inputs per second) for local or RTU data interfaced to master station equipment shall be defined for all applicable data types (see 5.4).

#### 4.2.3 Data processing

Data processing capabilities shall be defined for each equipment item and all applicable data types. Systems with report-by-exception functions shall have the capability to report all data for initialization and periodic update purposes.

##### 4.2.3.1 Analog data

Analog data is used to describe a physical quantity (i.e., voltage, current, shaft position, etc.) that normally varies in a continuous manner. The information content of an analog signal is expressed by the value or magnitude of some characteristic of the signal such as amplitude, phase angle, frequency, the amplitude or duration of a pulse, etc.

The analog data processing options to be supported at both the master station and the RTU shall be defined. This is the responsibility of both the user and supplier. Particular attention shall be given to input data validity processing (e.g., the validity of the data) and to the interface between the supervisory control function and the analog data processing function.

- a) Data input scaling shall give adequate consideration to off-normal operation of the power system (e.g., overvoltage, fault conditions, emergency load limits).
- b) Data change detection may be a function included as an alternative to processing every input on every scan. Data change detection is accomplished by testing to see if the new value for each input is within N digital counts (e.g., deadband) of the last stored value for that input. The new value shall replace the last stored value only if the deadband was exceeded and then the input will be further processed as defined below. When the data change detection function is included, the following characteristics shall be defined:
  - 1) Location of processing, RTU or master station, or both
  - 2) Range of N, RTU or master station, or both
  - 3) Definition of N on an RTU, card, or point basis
  - 4) Technique for changing value of N
- c) Data filtering may be required to smooth data before it is used by other functions. When this function is included, the equation used shall be defined and the time delay, introduced by the filtering, specified.
- d) Data limit checking is typically included to determine if other downstream functions, such as alarm detection, or further processing are required. The number of high or low limits accommodated and associated return-to-normal deadband processing shall be defined. Specific attention shall be given the procedure for user specification and revision of limit and deadband values.
- e) The data report-by-exception function is used to eliminate communication of unchanged data from the RTU(s) to the master station or submasters. Its input is received from the change detection function. When the analog data report-by-exception function is included the following characteristics shall be defined:
  - 1) Percent of analog changes per scan that results in the channel load associated with reporting all analog points from the RTU.
  - 2) Description of logic in the master station that can be used to select between using the analog data report-by-exception function or the report-all-analog data functions when acquiring analog data from each RTU.
- f) Data conversion to engineering units is typically required before analog data is used by other software, printed, or displayed as output. The mathematical equation(s) used to convert analog values represented by digital counts into the corresponding engineering units shall be defined. Specific attention shall be given to sensor and transducer scale factors that may be provided by the user.
- g) Bad data techniques shall be defined that are used to
  - 1) Detect an open input to an analog channel
  - 2) Identify reasonable values
  - 3) Detect a drifted or faulty A/D converter
  - 4) Automatically calibrate an analog channel

#### 4.2.3.2 Status data

Status data is used to describe a physical quantity (e.g., device position) that has various possible combinations of discrete states. The information content of a digital signal is expressed by discrete states of the signal such as the presence or absence of a voltage, current, or a contact in the open or closed position.

The status data processing options to be supported at the master station and the RTU shall be defined. This is the responsibility of both the user and supplier. Particular attention shall be given to input data validity processing, and to the interface between the supervisory control function and the status data processing function.

- a) Data change detection may be a function included as an alternative to processing every input on every scan. Data change detection is performed by testing to see if the current state is the same as the last stored state for that input. Changed data shall replace the last stored value and the point, or group of inputs, shall be routed to other functions such as data report-by-exception, alarm processing or both. When the data change detection function is included, the following characteristics shall be defined:
  - 1) Location of processing (RTU or master station)
  - 2) Quantity of data reported when a single input changes
  - 3) Minimum signal duration to be considered a change
  - 4) Minimum current required for detection
  - 5) Security against loss of change data

- b) Data report-by-exception function is used to eliminate unnecessary communication of unchanged data from the RTU(s) to the master station or submaster. Its input is received from the change detection function. When the status data report-by-exception function is included, the following characteristics shall be defined:
  - 1) Percent of status point changes per scan that result in the channel load associated with reporting all status points from the RTU.
  - 2) Description of logic in the master station or RTU that can be used to select between using the status report-by-exception or the report all status data function when acquiring status data from each RTU.
- c) Status with memory may be a function implemented in the RTU. When this function is included, the number of status changes accommodated and legal bit combinations supported by the design shall be defined.

#### 4.2.3.3 Accumulator data

The following characteristics shall be defined when pulse accumulation and accumulator data processing is included:

- a) Input circuit (two or three terminal and how input circuit operates)
- b) Sources of freeze command, if any (internal/external)
- c) Ranges of values (RTU and master station)
- d) Nominal and maximum counting rates
- e) Source of memory power
- f) Input voltage if externally powered
- g) Reset command (if any)

#### 4.2.3.4 Sequence-of-events (SOE) data

The following characteristics shall be defined when SOE data acquisition capability is included:

- a) Time resolution at RTUs
- b) Method of system time synchronization
- c) Time accuracy between any two RTUs
- d) Number of SOE inputs per RTU
- e) Size of buffers (number of SOE events that can be stored) per RTU
- f) Time (minimum/maximum) between successive change(s) of an input
- g) Method of indicating that SOE data is available at the RTU
- h) Data filter time constant and accuracy (e.g., contact de-bounce)
- i) Data time skew (introduced by de-bounce filters)
- j) Number of SOE events that can be transferred to the master station in one communications transaction

#### 4.2.3.5 Computed data

The following characteristics shall be defined when the capability of computing data (which are not directly measured) is included:

- a) Location (RTU or master station)
- b) Equations supported
- c) Resulting data types (numeric or logical, or both)
- d) Downstream functions (e.g., limit checking)

#### 4.2.3.6 Alarm data

The following characteristics shall be defined when the capability to process and report alarm conditions is included:

- a) Conditions reported as alarms
- b) Methods of acknowledgment (single or groups)
- c) Methods of highlighting alarms (e.g., flash, tone, etc.)

- d) Information in alarm messages
- e) Hierarchy of alarms (priority level)
- f) Size of alarm queue(s)
- g) Queue management (e.g., time ordered)
- h) Alarm limit(s)

#### 4.2.3.7 Digital fault data

The RTU(s) and their microcomputers are becoming sophisticated enough that they can monitor power waveforms at such a rate as to be able to record high resolution data for pre-fault, fault, and post-fault analysis. The following characteristics shall be defined when the capability to process and report digital fault data is included:

- a) Samples per cycle
- b) Number of data points per fault
- c) Maximum buffer size (total samples to be stored)
- d) Sample triggers
- e) Number of faults to be reported and stored
- f) Means of reporting digital fault data

#### 4.2.4 Supervisory control characteristics

When the capability to remotely control external apparatus and processes is provided, the characteristics of such a control capability shall be defined (see 5.4). Definition of characteristics common to all control interfaces shall include:

- a) Control sequence description
- b) Type of checkback message (echo or re-encoded)
- c) Security of control sequences
- d) Immediate operate controls
- e) Broadcast controls

##### 4.2.4.1 Equipment control with relay interface

Control using a relay output shall be defined as follows:

- a) Dwell time of relay contacts
- b) Number of relays that can be simultaneously energized in each type of RTU
- c) Processing actions (e.g., logging and alarm suppression)
- d) Ac or dc ampere and voltage ratings for relay contacts (see tables 1 through 8 in 5.4)

##### 4.2.4.2 Equipment control with setpoint interface

Control using a setpoint output shall be defined as follows:

- a) Resolution of setpoint value
- b) Duration of output value
- c) Processing actions (e.g., limit check, equation, and alarms)
- d) Electrical interface

##### 4.2.4.3 Equipment/process control with electronic interface

Control using an electronic interface shall be defined as follows:

- a) Timing diagram of signals
- b) Interface communication protocol
- c) Processing actions associated with control
- d) Physical interface

#### 4.2.5 Automatic control functions

When the capability to automatically control external apparatus is provided the characteristics of such control capabilities shall be defined as follows:

- a) Location of automatic control logic (RTU or master station)
- b) Control equation(s)
- c) Feedback value and accuracy, if closed loop
- d) Frequency of execution
- e) User alterable control parameters
- f) Associated logging or alarming
- g) Method of altering control logic

#### 4.2.6 User interface characteristics

User interface functions shall be defined when the capability to support operating or maintenance personnel at either the master station or RTU is included. The interface functions shall be defined according to the following in 4.2.6.1 through 4.2.6.4.

##### 4.2.6.1 Control of equipment functions

When operator controllable functions are included the applicable characteristics shall be defined for the included functions, such as

- a) Control output options
  - 1) Enable/disable
  - 2) Tagging (types and uses)
  - 3) Local/remote
  - 4) Open (off)/close (on)
- b) Control of data acquisition
  - 1) Enable/disable scan (inputs or stations)
  - 2) Enable/disable processing
  - 3) Manual entry of data
  - 4) Change scan frequency by group
  - 5) Assign/reassign data to a group
- c) Control of data processing
  - 1) Setting date and time
  - 2) Setting input change limits
  - 3) Defining formats
  - 4) Defining conversion data
  - 5) Defining operator override values
  - 6) Defining normal/abnormal status
- d) Control of alarm processing
  - 1) Enable/disable individual alarms
  - 2) Enter/edit alarm limit value(s)
  - 3) Enter/edit alarm deadband value(s)
  - 4) Enter/edit return-to-normal criteria
  - 5) Enter/edit alarm assignment to area of responsibility
  - 6) Enter/edit alarm priority

- 7) Acknowledge alarms (individual/page)
- 8) Silence audible alarm
- 9) Inhibit alarms
- 10) Override invalid alarms
- e) Control of function checks
  - 1) Enable/disable
  - 2) Change frequency
- f) Control of automatic control functions
  - 1) Enable/disable
  - 2) Modify criteria
  - 3) Add/delete control functions
  - 4) Reset to reference level or position

#### 4.2.6.2 CRT display functions

The applicable characteristics shall be defined when the following CRT formats are included:

- a) Generation of display formats
  - 1) Format definition capabilities
  - 2) Symbols supported
  - 3) Memory per format
  - 4) Use of colors
  - 5) Use of special features (flash, inverse video, etc.)
  - 6) Control level of detail (declutter)
  - 7) Display call-up time
  - 8) Use of features (pan, zoom, windowing, etc.)
- b) Standard formats
  - 1) Index formats
  - 2) System formats
  - 3) Communication channel format
  - 4) Summary of inhibited alarms
  - 5) Input point profile formats
  - 6) Alarm summary
  - 7) Tag summary
  - 8) Abnormal summary
  - 9) Override summary
  - 10) Alarm inhibit summary
  - 11) Station notes format
- c) Control of CRT and cursor
  - 1) Cursor operation
  - 2) Selection of formats
  - 3) Response time
  - 4) Update cycle (from database)
  - 5) Paging of multi-page formats
  - 6) Selection of declutter (zoom) levels

#### 4.2.6.3 Digital and analog display functions

When such display devices are supported the applicable characteristics shall be defined as follows:

- a) Digital displays
  - 1) Numeric range with decimal
  - 2) Update frequency
  - 3) Minimum value supported
  - 4) Maximum value supported

- b) Analog displays
  - 1) Ranges
  - 2) Update frequency
  - 3) Minimum value supported
  - 4) Maximum value supported

#### 4.2.6.4 Hard copy functions

When support of hard copy devices is required such as loggers, strip chart recorders, and video copiers, the applicable characteristics shall be defined as follows:

- a) Device assignments
  - 1) Initial
  - 2) Automatic reassignment
  - 3) Manual reassignment
- b) Generation of log formats
  - 1) On-line/batch capabilities
  - 2) Symbols supported
  - 3) Spooling capabilities
- c) Demand logs
  - 1) Standard formats
  - 2) Time for response
- d) Logged activities
  - 1) Alarms
  - 2) Standard events (e.g., user and device actions)
  - 3) System events (e.g., equipment failover and communication failure)
  - 4) Output from diagnostic routines
- e) Device performance
  - 1) Print speed (characters per second)
  - 2) Print quality (dots per inch)
  - 3) Color requirements

#### 4.2.7 Sub-master RTU

An RTU can act as a master station with respect to other slave RTU(s) and Intelligent Electronic Device(s) [IED(s)]. The master station functions allocated to such sub-master RTU shall be defined using the applicable preceding subclauses. This is the responsibility of both the user and supplier. The user shall define the applicable characteristics as follows:

- a) Database
- b) Communication protocol
- c) Point configuration
- d) Scan interval
- e) Downloading characteristics
- f) Other characteristics defined in this standard that may be applicable

#### 4.2.8 Computer backup and failover

It is common practice today to reconfigure a system by switching peripherals or the total computer sub-system in order to recover from a peripheral or computer failure. In a distributed computer implementation, functions may be reallocated to recover from a hardware failure. The applicable characteristics shall be defined when both primary and backup facilities are provided as follows:

- a) Database backup
  - 1) Data residency (bulk or main memory)
  - 2) Frequency of backup (by data type)
  - 3) Other uses of backup facilities
- b) Database update
  - 1) Data residency (bulk or main memory)
  - 2) Frequency of update (by data type)
  - 3) Other uses of update facilities
- c) Failure monitoring
  - 1) Method of failure detection
  - 2) Response time for detection
  - 3) Effect on a program or task in progress when failover occurs
- d) Failover
  - 1) Method of failover
  - 2) Time required for failover
  - 3) User interface response following failover
  - 4) User actions following failover
  - 5) Effect on a program or task in progress when failover occurs

#### 4.2.9 Historical data

The appropriate characteristics shall be defined when the capability for historical data archiving and retrieval is included as follows:

- a) Number of history files supported
- b) Data quantities per file
- c) Data intervals per file
- d) Number of data intervals per file
- e) Method of file management
- f) Method of data archiving
- g) Method of data retrieval
- h) Data usage (e.g., displays, reports, applications, etc.)

#### 4.2.10 Local area networks

Local area networks may be used to provide data exchange capability between the different functions at a site (e.g., solid state relays, IEDs, RTUs, etc.). When the capability of a local area network is included, the characteristics of such communication capability shall be defined as follows:

- a) Bit rate
- b) Electrical interface (e.g., RS-232, RS-485, etc.)
- c) Equipment to be interconnected
- d) Transfer rate (bytes per second)
- e) Protocols (e.g., Ethernet, TCP/IP, etc.)
- f) Redundancy
- g) Reliability (e.g., sectionalizing for isolating failures)

## 5. Interfaces

The control and data acquisition equipment shall have interfaces as described in this clause. The interfaces described consist of those illustrated in figure 5.

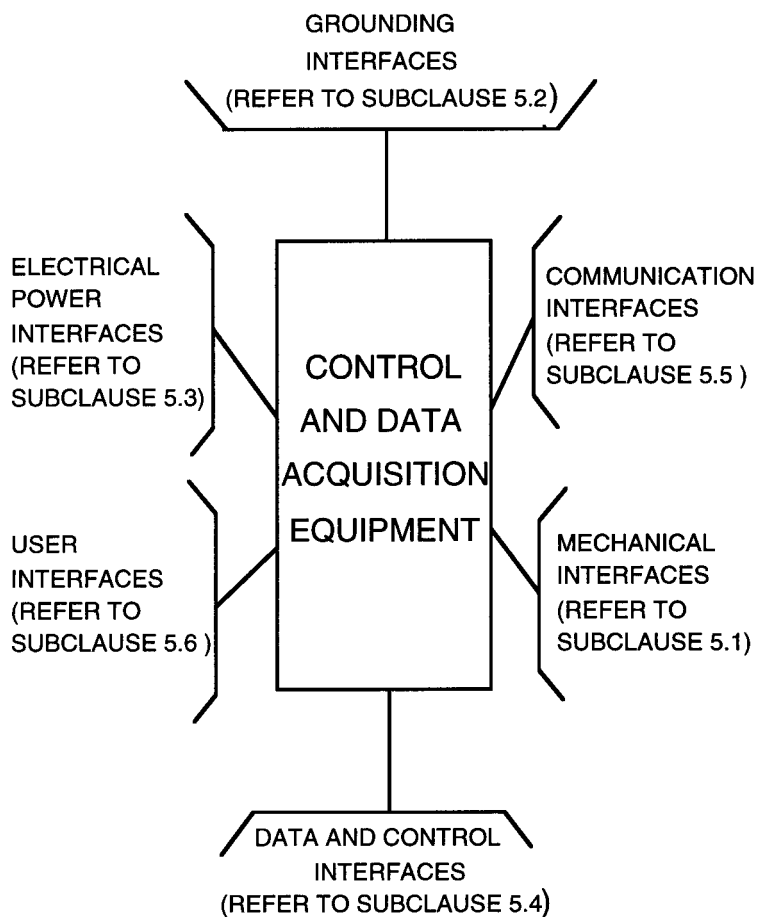

**Figure 5— Manual, automatic, and supervisory control equipment interface block diagram**

## 5.1 Mechanical

### 5.1.1 Enclosures

Equipment enclosures shall be suitable for the proposed environment. Enclosure specifications are found in NEMA 250-1991, which typically applies to harsh environments and ANSI/EIA 310-D-1992, which typically applies to controlled environments.

### 5.1.2 Special requirements

The location of access doors, enclosure mounting requirements, temperature/ventilation requirements, terminal-block type and location, cable entry locations, and special cabling and connector requirements should be specified for individual applications.

When required, electromagnetic shielding characteristics of enclosures should be determined in conformance with [B20].<sup>8</sup>

<sup>8</sup>The numbers in brackets correspond to those bibliographical items listed in annex C.

## 5.2 Grounding

Control and data acquisition equipment shall not ground a floating power source. Care shall be exercised to ensure ground compatibility when grounded power sources are used.

### 5.2.1 Safety or equipment ground

The safety or equipment ground protects personnel from injuries caused by live or hot conductors coming in contact with the equipment cabinet or enclosure. The ground conductor shall be bundled with the power conductors, but be insulated from the power conductors and from other equipment and conduit. The ground conductor is usually terminated in the cabinet enclosure, and grounded only at the same point that the electrical service or UPS neutral is grounded. All cabinets and/or enclosures comprising any control or data acquisition equipment shall be grounded together by means of a ground cable or strap.

Additionally, metal decking or other electrical paths should be grounded only at the same point that the electrical service or UPS is grounded. Safety or equipment grounds shall be established in accordance with the National Electrical Code (NEC) (ANSI/NFPA 70-1993).

### 5.2.2 Signal or instrumentation circuit ground

The signal or instrumentation circuit ground shall be connected to an external ground at a single point so that ground loop conditions are minimized. The shielded wire, drain wire, and/or ground wire of input/output cables shall be terminated at one ground point in each cabinet. These ground points shall be connected together and connected to the facility ground. Caution shall be used to prevent inadvertent ground paths from apparatus such as convenience outlets, conduit, structural metal, test equipment, and external interfaces.

A special caution on filtering is worth noting. If the "noise" is shunted to the signal ground, then it becomes another source of signal reference corruption. Sometimes separate power, noise, digital, and analog ground buses are necessary. However, the NEC requirement for a single point safety grounding source shall always be met. A very important design rule is to keep all signal reference voltages, at all frequencies of operation, as close to zero as possible (i.e., at zero voltage signal reference).

### 5.2.3 Electrical ground

The station power source shall be grounded in accordance with the NEC.

## 5.3 Electrical power

The electric power interfaces to control and data acquisition equipment shall meet the following requirements:

The alternating current source defined below may originate directly from the station source or from a regulating/uninterruptible power supply.

Equipment operating on direct current shall not sustain damage if the input voltage declines below the lower limit specified or is reversed in polarity.

### 5.3.1 Master station

Master station equipment shall be capable of operating without error or damage with one or more of the following source voltage ranges:

- a) 120/240 Vac  $\pm$  10% single phase or three phase at 60/50 Hz  $\pm$  0.5%
- b) 208Y/120 Vac  $\pm$  10% three phase at 60 Hz  $\pm$  0.5%

- c) 21 to 29 Vdc (24 Vdc nominal)
- d) 42 to 58 Vdc (48 Vdc nominal)
- e) 105 to 145 Vdc (125 Vdc nominal)
- f) 210 to 290 Vdc (250 Vdc nominal)

### 5.3.2 Remote station

Remote station equipment shall be capable of operating without error or damage with one or more of the following source voltage ranges:

- a) 120/240 Vac  $\pm$  10% single phase at 60/50 Hz  $\pm$  1%
- b) 21 to 29 Vdc (24 Vdc nominal)
- c) 42 to 58 Vdc (48 Vdc nominal)
- d) 105 to 145 Vdc (125 Vdc nominal)
- e) 210 to 290 Vdc (250 Vdc nominal)

### 5.3.3 Power quality

Station power shall be of such quality (free from noise, spikes, etc.) to be suitable for use as a source to electronic equipment. The user and supplier shall both be responsible for conditioning (as required) the electric substation power for use by SCADA equipment.

### 5.3.4 Internal noise

The control and data acquisition equipment internally generated electrical noise, from 1000 to 10 000 Hz, appearing on the power source terminals shall be less than 1.5% (peak to peak) of the external power source voltage. This is measured into an external power source impedance of 0.1  $\Omega$  minimum.

### 5.3.5 Surge withstand capability (SWC)

The electrical power interfaces (e.g., input power to the RTU) shall be designed to withstand, without RTU damage, misoperation, or data corruption, the surge withstand capability tests as defined in IEEE Std C37.90.1-1989 .

## 5.4 Data and control interfaces

Data and control interfaces consist of electrical interconnections between control and data acquisition equipment and the apparatus being monitored and controlled. Two types of signal paths are defined as follows:

- a) Data paths—Inputs to data acquisition or supervisory control equipment
- b) Control paths—Outputs from data acquisition or supervisory control equipment

For each input (data) or output (control) path, various signal characteristics shall be defined to specify the interfaces between equipment. Where possible, the preferred signal characteristics defined in this standard should be specified. The range of user application varies widely, so that it is not possible to establish a standard for all signal characteristics discussed below. In these instances the user shall specify the applicable characteristics.

Data and control signal cabling, which are external to control and data acquisition equipment, are not specified. The following design guidelines may be used:

- a) IEEE Std 422-1986
- b) IEEE Std 525-1992

Tables 1 through 8 address the parameters typically associated with each data or control signal. The user and supplier may agree to specifications other than those listed whenever unique conditions suggest an alternate interface. The user should identify the required expansion (see 7.5) for each type of data and control interface.

#### **5.4.1 Surge withstand capability (SWC)**

The electrical data and control interfaces (e.g., inputs and outputs to the RTU) shall be designed to withstand the surge withstand capability tests as defined in IEEE Std C37.90.1-1989 without RTU damage, misoperation, or data corruption.

**Table 1— DC analog input signals**

Parameter	Specifications	Notes
Nominal input signal range	$\pm 1$ mA or 4–20 mA	$\pm 5$ V with normalizing resistance less than 5 k $\Omega$ is acceptable
Maximum input signal range	$\pm 2$ mA or 3–24 mA	Limited by the transducer to 2 mA
Maximum input signal (nonoperating)	200 V peak	dc to 60 Hz, to prevent RTU damage when connecting to source outside range specified
Maximum input signal resistance (includes overload protection)	10 k $\Omega$ 600 $\Omega$	For 1 mA current inputs For 4–20 mA inputs
Conversion resolution, minimum (with sign)	12 b	Binary data format (includes sign)
Maximum error at 25 °C	$\pm 0.1$ %	Percent of nominal input signal range for a single sample
Maximum temperature error*	$\pm 0.005\%/^{\circ}\text{C}$	Percent nominal input signal range (2 mA)
Maximum common-mode voltage (operating)	200 V peak	dc to 60 Hz referred to equipment ground
Minimum common-mode rejection	90 dB	dc to 60 Hz
Minimum differential (normal)—mode rejection	60 dB	At 60 Hz

\*Associated with the operating temperature (see table 10).

**Table 2— AC analog input signals<sup>a</sup>**

Parameter	Specifications	Notes
Nominal input signal range	1 A, 5 A or 6 V, 69 V, 120 V	Alternating current 50/60 Hz
Maximum input signal range	2 A, 10 A, or 138 V, 240 V	Continuous rms values
Overload input signal rating	CT-40 · nominal, 1 s PT-2.5 · nominal, 10 s	—
Maximum input signal burden	3 VA	Shall not exceed 1 VA in a current element
Conversion resolution, minimum (with sign)	12 b	Binary data format (includes sign)
Maximum error at 25 °C	$\pm 0.1\%$	Percent of nominal input signal range for a single sample
Maximum temperature error	$\pm 0.005\%/^{\circ}\text{C}$	Percent of nominal input signal range
Maximum common-mode voltage (operating)	200 V peak	dc to 60 Hz referred to equipment ground
Minimum common-mode rejection	90 dB	dc to 60 Hz
Common ground return	None	Electrically isolated
Insulation level	600 V	1500 V RMS for 1 min
Anti-aliasing filter	Specify	Cutoff less than one-half A/D sampling rate

<sup>a</sup>600 V insulation class, 1200 V hi pot, all isolated (ungrounded).

<sup>b</sup>Associated with the operating temperature (see table 10).

**Table 3— DC analog output signals**

Parameter	Specifications	Notes
Nominal output signal range	$\pm 1$ mA 4–20 mA	Constant current into a burden of 0 to 10 k $\Omega$ $\pm 5$ V range of voltage output is acceptable
Maximum output signal range	$\pm 1.2$ mA	—
Maximum output load	10 k $\Omega$ 600 $\Omega$	10 k $\Omega$ minimum for voltage outputs 600 $\Omega$ minimum for voltage outputs
Maximum error at 25 °C	$\pm 0.1\%$	Percent of nominal output signal range (2 mA) includes offset, noise scale factor, and calibration error over six-month period
Maximum temperature error*	$\pm 0.005\%/^{\circ}\text{C}$	Percent of nominal output signal range (2 mA)
Conversion resolution, minimum (with sign)	12 b	Binary data format
Common ground return	None	Electrically isolated
Maximum common-mode voltage (operating)	200 V peak	dc to 60 Hz referred to equipment ground
Maximum common-mode error	$\pm 0.1\%$	Percent of nominal output signal range (2 mA)

\*Associated with the operating temperature (see table 10).

**Table 4— Digital electronic input signals**

Parameter	Specifications	Notes
Input data format	Specify	Application dependent
Common ground return	No	Optical coupler or equivalent
Signal voltage range	0 to 20 V	—
Signal current range	0 to 20 mA	—
Signal data rate	Specify	—
Signal duration	Specify	—

**Table 5— Digital electronic output signals**

Parameter	Specifications	Notes
Output data format	Specify	Application dependent
Common ground return	None	Optical coupler or equivalent
Signal voltage range	0 to 30 V	—
Signal current range	0 to 50 mA	—
Signal data rate	Specify	—
Signal duration	Specify	—

**Table 6— Contact (electromechanical) inputs**

Parameter	Specifications	Notes
External contact forma	Specify	Dry contact. Form A is typical
Minimum signal voltage	12 V, dc	Minimum for substation power. Station battery may be used subject to EMI restrictions
Minimum signal current	10 mA	New equipment may require only 2 mA
Settable debounce time	2–128 ms	Digital filter adjustments
Minimum change detection time	0.5 ms	—
Maximum change detection time	1 ms	—
Maximum contact resistance	100 $\Omega$	Includes cable resistance
Minimum leakage resistance (at operating voltage)	50 k $\Omega$	Includes cable leakage resistance

**Table 7— Accumulator inputs**

Parameter	Specifications	Notes
External contact format	Specify	Dry contact. Form C is typical
Minimum signal voltage	12 V, dc	Station battery may be used subject to EMI restrictions
Minimum signal current	10 mA	In metering ac is normal; new equipment may require only 2 mA
Minimum change detection time	30 ms 1 ms	If electromechanical If solid state
Counts per contact cycle	Specify	With de-bounce filter
Maximum count rate	10	Per second
Minimum accumulator count range	9999	15 min at maximum rate
Accumulator freeze/retrieve command	Specify	—
Non-volatile memory	Specify	—

**Table 8— Contact (electromechanical) outputs**

Parameter	Specifications	Notes
Output contact format	Specify	Dry contacts
Contact current rating	10 A	Typical range 1 A to 30 A ac or dc
Contact voltage rating	125 V, dc	Resistive load
Activation time adjustable (0. 1 to 30 s)	Yes	—
Latched outputs available	Yes	—

## 5.5 Communication

### 5.5.1 Master station/RTU links

Communication interfaces consist of functional, mechanical, and electrical interconnections between control and data acquisition equipment and the communication apparatus. Any specific application requires one of the two following types of general signal interfaces. For more information, see clause 5. in IEEE Std 999-1992 .

Signal interfaces between the control and data acquisition equipment and the data communication equipment (e.g., a data modem) occur whenever the data communication equipment is not packaged as an integral part of the control and data acquisition equipment, as illustrated in figure 6.

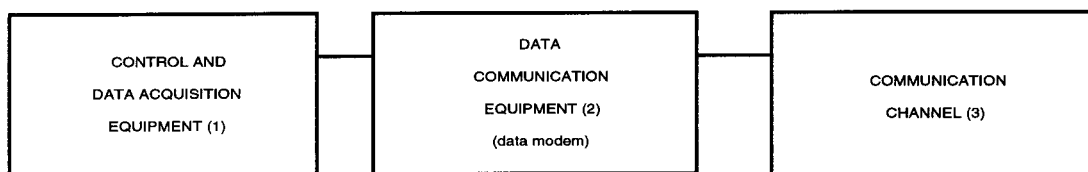

#### NOTES:

- 1 — This equipment is called data terminal equipment (DTE) in ANSI AND EIA standards referenced in this clause.
- 2 — This equipment is commonly called a data modem, but called data communication equipment (DCE) in referenced standards.
- 3 — Channel includes microwave, radio, cable, fiber optic, and power-line carrier types.

**Figure 6— Signal interfaces between control and data acquisition equipment and data communication equipment**

Signal interfaces between the control and data acquisition equipment and a communication channel are illustrated in figure 7.

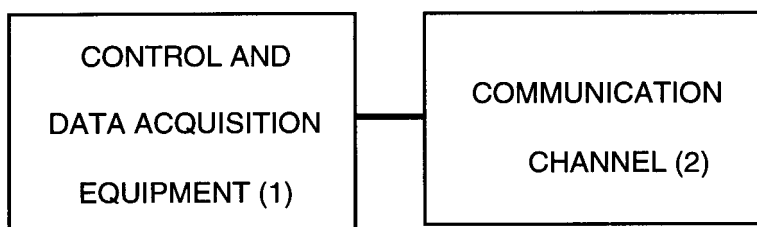

#### NOTES:

- 1 — Data modem is packaged as an integral part of this equipment.
- 2 — Channel includes microwave, radio, cable, fiber optic, and power-line carrier types.

**Figure 7— Signal interfaces between control and data acquisition equipment and communication channel**

Subsequent subclauses define specific signal characteristics for these mentioned interfaces. However, two characteristics are common to both types of interfaces and shall be measured regardless of the configuration utilized. These characteristics are

- a) SWC measured between data communication equipment and the communication channel (see clause 9.). The SWC criteria is defined in IEEE Std C37.90.1-1989. IEEE Std C37.90-1989 shall be used in common mode only with the channel connected to the data communication equipment.
- b) Channel bit error rate is measured between data communication equipment and control and data acquisition equipment. Due to the variety of channel and modem qualities available and in use, an average value of 1 b error in  $10^4$  b is recommended for design and analysis purposes.

#### **5.5.1.1 Interface characteristics to external data communication equipment (e.g., modem) not integrally provided**

The following are the interface characteristics:

- a) *Interface signals.* As a minimum each interface shall satisfy the requirements as defined in EIA TIA-530-A-1992, category 1.  
All circuits used shall be implemented with drivers and receivers according to EIA 423-A-1978 for unbalanced voltage digital interface circuits. Where modems equipped with digital interfaces according to EIA TIA-232-E-1991 are to be utilized, the necessary adapters described in EIA IEB12-1977 shall be provided as part of the control and data acquisition equipment.
- b) *Signal repetition rate.* All rates shall be in accordance with ANSI X3.1-1987.
- c) *Signal quality.* All signals shall meet EIA 363-1969 and ANSI/EIA 404-1985 for asynchronous DCE and ANSI/EIA 334-A-1985 for synchronous DCE.
- d) *Noise limits.* These are defined in the references given in c).

#### **5.5.1.2 Interface characteristics to internal data communication equipment (e.g., modem) when the modem is provided as an integral part of the control and data acquisition equipment**

The following are the interface characteristics:

- a) *Signal impedance.* All inputs and outputs shall be balanced  $600 \Omega \pm 10\%$  whenever signal rates require standard voice grade channels.
- b) *Signal level.* Input (receive) levels may range down to  $-45$  dBm and output (transmit) levels shall not exceed 0 dBm. The output level and receive sensitivity shall be adjustable in steps of 4 dB or less.
- c) *Signal stability.* All inputs and outputs shall be stable within  $\pm 1$  dB for at least one month without adjustment.
- d) *Signal linearity.* The output (transmit) shall be linear within  $\pm 1$  dB over the level range and frequency allowed. Input (receive) linearity and delay distortion are not defined and should be specified for each channel type and data rate required.
- e) *Signal distortion.* All input and output signals shall not contain rms harmonics that exceed 2% dBm whenever signal rates require standard voice grade channels.
- f) *Signal carrier.* Specify center frequency and bandwidth.

#### **5.5.1.3 Protocol**

The data communication between master station and RTU shall utilize an orderly communication protocol defined in terms of message standards. Message standards shall be defined in accordance with the general format described below. There are a number of supplier-specific and industry standard protocols available that may be suitable. The user and the supplier must agree on the protocol to be used. The following message format segments shown apply to both fixed and variable length message standards.

<b>MESSAGE ESTABLISHMENT</b>	<b>INFORMATION (DATA OR CONTROL)</b>	<b>MESSAGE TERMINATION</b>
----------------------------------	--	--------------------------------

The message establishment segment includes signals required to synchronize data communication equipment and address station equipment.

The information segment includes signals associated with point addresses, point data values, commands, and other codes that are used by station equipment.

The message termination segment includes signals used for message security and end-of-message purposes by station equipment.

The order of data transmission (least or most significant bit first), the signal states (mark, center, space), and the state values (mark = 0 or 1) shall be specifically defined.

To exchange information, one station sends a message to another station, which in turn responds with an appropriate message. If an error is detected in either message, that part of the message, or the message sequence, may be repeated one or more times. A message transaction is complete when both the initial message and reply message have been received without error. For more information, see clause 6. in IEEE Std 999-1992 .

#### **5.5.1.4 Channel considerations**

The routine loading of each communication channel by SCADA equipment shall be calculated as described in annex C to establish the adequacy of the channel configuration. The channel routine load factor is defined as the worst-case fractional channel operating time required to complete all routine (i.e., periodic) data and control transactions between the master station and the attached RTU(s). Where report-by-exception data acquisition techniques are employed, realistic assumptions for the average number and length of exception transactions during the repetition interval shall be made. The repetition interval of SCADA system periodic transactions typically ranges from seconds to hours. For more information, see A.3 in IEEE Std 999-1992 .

It is recommended that the channel routine load factor, with fully-expanded RTUs, should be less than 0.75. The remaining channel capacity will then be available for occasional retransmissions and for event-driven data and control transactions. To minimize the incidence of message failures due to channel errors, it is also recommended that transaction lengths be limited to about 250 channel bit times. When the channel bit error rate reaches one in 10 000 b, 2.5% of such transactions will fail. Automatic repetition (retry) of transactions that fail may be implemented but no more than three consecutive retries should be permitted. If the transaction is not completed satisfactorily at the fourth attempt, the relevant RTU, or the channel itself, should be declared at least temporarily inoperative.

#### **5.5.2 Sub-master/slave RTU links**

The sub-master/slave RTU links shall consist of at least one communication link to a master station as well as at least one additional link to slave RTUs, or a link to a distributed RTU module of the same RTU, or a link to an intelligent electronic device (IED).

##### **5.5.2.1 Sub-master RTUs**

The communications link(s) to the master station(s) is identical to that described in 5.5.1.

### 5.5.2.2 Remote terminal units

The communication links to slave RTUs is similar to that described in 5.5.1, except that the role of the master station is assumed by the sub-master RTU. The protocol used need not be the same as that used between the sub-master RTU and the master station. Indeed, it is usually the case that the protocols are not the same.

### 5.5.2.3 Distributed RTU modules

The communications link between the distributed RTU network controller and the I/O modules is usually a proprietary design of the RTU supplier. The definitions and descriptions of this link are beyond the scope of this standard.

### 5.5.2.4 IEDs

The interface described in 5.5.1.1 is typical. These interfaces vary among IED suppliers. The user is cautioned that coordination and specific definitions may be required when interfacing with IEDs. Further, the user is cautioned that the master station RTU protocol may not support the acquisition of data from, and the control of, the IEDs.

## 5.6 User interface (UI)

The user interface is defined as the user contact with the control and data acquisition equipment.

MIL-STD 1472D-1989 is recommended as a reference for use in the design and evaluation of the user interface to equipment. Alternative human engineering data may be specified by the user. The user interface for operation concerns standards and recommendations for information displays, control capabilities, colors, and user interaction with the equipment.

### 5.6.1 Information displays

Characters used by printers, loggers, and illuminated displays shall have unique codes so that their display may be electrically initiated. The alphanumeric characters and their corresponding codes as defined in ANSI X3.4-1986 shall be used to represent alphanumeric data at the user interface. A minimum set of graphic symbols is recommended in table 9.

### 5.6.2 Control capabilities

The capabilities provided for operator inputs at the user interface are defined as the control capabilities. The control capabilities may include a combination of the following:

































- a) Keys and switches (alphanumeric or function, or both)
- b) Cursor (mouse, trackball, joy stick, or key controlled)
- c) Light pen
- d) Poke points (defined CRT displayed control selection fields)
- e) Pull down or pop up menus

The user's input to the UI equipment shall be recognized and acknowledged (valid or invalid) to the operator within 0.5 s. The UI equipment shall confirm control actions using the reencoded checkback message from the RTU within 2 s.

When labeled function push buttons are included in control and data acquisition equipment, the labels shall be legible from a distance of approximately 1 m in the user specified environment. When lighted push buttons are included, the significance of the state of the light (on, off, blinking) shall be clearly defined and shall be consistent throughout the system.

Control push buttons (e.g., raise, lower, trip, open, and close) shall be within convenient viewing distance of the information display that will be used during the control operation.

**Table 9— Recommended electrical graphic symbols and meanings**

Symbol	Meaning	Symbol	Meaning	Symbol	Meaning
	CORNER, UPPER LEFT		LINE, VERTICAL		CORNER, UPPER RIGHT
	GENERATOR		LINE, HORIZONTAL		BUS
	OPEN BREAKER		LINE, CROSSOVER		FLOW UP
	CLOSED BREAKER		LINE JUNCTION		FLOW DOWN
	OPEN DISCONNECT		LINE JUNCTION		FLOW LEFT
	CLOSED DISCONNECT		LINE JUNCTION		FLOW RIGHT
	TRANSFORMER		LINE JUNCTION		BUS
	TRANSFORMER		LINE/BUS JUNCTION		GROUND SWITCH
	CAPACITOR		LINE/BUS JUNCTION		GROUND SWITCH
	CAPACITOR		LINE/BUS JUNCTION		GROUND
	CORNER, LOWER LEFT		LINE/BUS JUNCTION		CORNER, LOWER RIGHT

### 5.6.3 Color codes

The standard meanings for colors (e.g., CRT displays, status lights) used at the UI to highlight the condition of apparatus monitored and controlled through control and data acquisition equipment shall be defined by users.

The significance of colors shall be consistent throughout the system.

The color status of an apparatus under operator control shall only change to its new state (may include attributes such as color and shape change, flashing, etc.) after the status of the apparatus has changed.

### 5.6.4 Interactive dialog

The activity at the UI during operational use of control and data acquisition equipment shall be clearly described and shall be consistent throughout the system.

### 5.6.5 Alarms

When alarm conditions detected by control and data acquisition equipment are first interfaced to the user, both an audible (voice, tone, or bell) and visual (flashing light or symbol) annunciation shall be presented. It shall be possible to silence the audible alarm without affecting the visual annunciation. The visual indication of each alarm condition shall remain as long as the alarm condition exists.

### 5.6.6 Dialog during control

The selection of a point for a user control action shall result in a visual feedback at the user interface. This positive feedback to the user shall signify that the control and data acquisition equipment is ready to accept a control action. The results of the control action (check-before-operate or direct operate) shall be displayed only after a status change has been received from the RTU equipment.

## 6. Environmental conditions

This clause contains a definition of the environment in which control and data acquisition equipment is required to operate.

There are unusual conditions that, where they exist, shall receive special consideration. Such conditions shall be brought to the attention of those responsible for the application, manufacture, and operation of the equipment. Devices and apparatus for use in such cases may require special construction or protection. The user should specify those special physical requirements that apply to specific locations. Examples are

- a) Damaging fumes or vapors, excessive or abrasive dust, explosive mixtures of dust or gases, steam, salt spray, excessive moisture, or dripping water
- b) Abnormal vibration, shocks, or tilting
- c) Radiant or conducted heat sources
- d) Special transportation or storage conditions
- e) Unusual space limitations
- f) Unusual operating duty, frequency of operation, difficulty of maintenance
- g) Altitude of the operating locations in excess of 2000 m (6600 ft)
- h) Abnormal electromagnetic interference
- i) Abnormal exposure to ultraviolet light

## 6.1 Environment

### 6.1.1 Ambient temperature and humidity conditions

Ambient temperature and humidity are defined as the conditions of the air surrounding the enclosure of the equipment (or the equipment itself, if it uses open rack construction) even if this enclosure is contained in another enclosure or room.

For temperature and humidity parameters by operating location, see table 10. This table is a guideline to establish five equipment classification groups. Equipment designated to be in a specific group shall meet all conditions set forth in that group.

Equipment subjected to temperature and humidity variations outside of the first four group classifications listed in table 10 will require special consideration. Methods to resolve these problems include the following:

- a) *Low temperature.* A thermostatically controlled heater strip should be used in the cabinet enclosure or use wide temperature range equipment.
- b) *High temperature.* A sun shield, some other cooling method, or wide temperature range equipment should be used.
- c) *High humidity.* Heater strips or special shelters should be used.
- d) *Low humidity.* A humidifier should be used to maintain acceptable humidity levels.

- e) *Temperature restrictions.* If it is necessary to use heating/cooling equipment to meet the parameters set forth in table 10, the equipment should be so marked by a warning sign and a warning statement in the associated documentation.

**Table 10— Operating temperature and humidity by location**

Equipment group	Typical location of the equipment	Humidity operating range (percent relative humidity)	Temperature operating range (°C)	Allowable rate of change of temperature (°C/h)
(1)(a)	In a building with airconditioned areas	40 to 60	+ 20 to + 23	5
(1)(b)	In a building with airconditioned areas	30 to 70	+15 to + 30	10
(2)	In a building with heating or cooling but without full air conditioning	10 to 90 without condensation*	+ 5 to + 40	10
(3)	In a building or other sheltered area without special environmental control	10 to 95 without condensation*	0 to +55	20
(4)	Outdoors or location with wide temperature variations	10 to 95 without condensation	−25 to + 60	20
(5)	Extremes outside the above	User to specify (see 6.1.1)	User to specify (see 6.1.1)	User to specify (see 6.1.1)

\*Maximum wet bulb temperature of 35 °C.

### 6.1.2 Dust, chemical gas, and moisture

Suppliers shall be made aware of the presence of atmospheric pollutants so that special provisions for protection can be made where necessary.

In groups (1), (2), and (3) of table 10, all equipment cabinets that are vented shall have dust filters. In groups (3) and (4), equipment that is exposed to moisture, corrosive or explosive gases, or other unusual environmental conditions shall have a special enclosure. Available types of enclosures for various conditions are specified in NEMA 250-1991.

Consideration should be given to possible contamination inside the enclosure during storage and transit, and also when the enclosure is opened for maintenance or repairs.

### 6.1.3 Altitude

The equipment shall be suitable for operation at altitudes up to at least 2000 m (6600 ft).

### 6.1.4 Ultraviolet (UV) light exposure

Suppliers shall be made aware of the expected level of exposure to ultraviolet radiation attributable to sunlight where equipment is to be installed outdoors. Equipment cabinets, paint finishes, and jacket material of any exposed cabling shall be sufficiently treated to resist damage or degradation due to UV exposure. The user shall supply information pertaining to altitude above mean sea level and the anticipated average daily hours of direct exposure to sunlight.

## 6.2 Vibration and shock

### 6.2.1 Operation

Where control and data acquisition equipment will be subjected to vibration or shock, the user shall express the local vibration environment as constant velocity lines to represent vibrational severity levels over a specified frequency range.

Four severity classes are listed in table 11 as examples in typical locations.

**Table 11— Classes of vibrational severity**

Class	Velocity v (mm/s)	Frequency range (Hz)	Examples
V.S.1	<3	1 to 150	Control room and general industrial environment
V.S.2	<10	1 to 150	Field equipment
V.S.3	<30	1 to 150	Field equipment
V.S.4	<300	1 to 150	Field equipment including transportation
V.S.X	>300	—	To be specified

Source: IEC654-3 (1983), Operating Conditions for Industrial Process Measurement and Control Equipment, Part III, Mechanical Influences.

Shock phenomena that may occur during handling for operation and maintenance of equipment shall be expressed in terms of an equivalent height of fall. This relationship is shown in table 12.

**Table 12— Shock phenomena**

Height of fall (mm)	Treatment (hard surface)
25	Light handling
50	Light handling, heavy material (>10 kg)
100	Normal handling
250	Normal handling, heavy material
1000	Rough handling
1500	Rough handling, heavy material

Source: IEC654-3 (1983), Operating Conditions for Industrial Process Measurement and Control Equipment, Part III, Mechanical Influences.

### 6.2.2 Transportation

Special care shall be used in the transportation of equipment. The equipment shall be packaged and braced so as to prevent damage during transit. Items such as swinging panels shall be strapped and blocked to minimize stress on the hinges.

All control and data acquisition equipment shall show no degradation of mechanical structure, soldered components, plug-in components, or operation after shipping.

### 6.3 Seismic environment

The purpose of this subclause is to describe the analytical and test criteria for equipment that is specified by the user to operate in an environment subject to seismic disturbance. The user shall supply, during system development, information that will allow the supplier to make a seismic equipment analysis and submit an equipment seismic report (e.g., for relays, see IEEE Std C37.98-1987 ).

#### 6.3.1 Seismic equipment analysis

The user shall supply a response spectrum in the form of frequency vs. amplitude for the location site of the equipment to be installed. Alternately, the user may supply information, on which the supplier is to base the analysis, listed in the following:

- a) Earthquake reports, which can be furnished by the California Institute of Technology, Earthquake Engineering Laboratory, Pasadena, CA
- b) Data pertaining to typical foundations and soils
- c) A study of the support structures
- d) An indication of the seismic zone in which the equipment is to be installed (see [B31]).

#### 6.3.2 Equipment seismic report

The following information is typically required as part of an equipment seismic report:

- a) An outline drawing of the equipment locating the centers of gravity, weights of major components, and the location and size of holddown bolts
- b) The maximum vertical and horizontal forces, and the upsetting moments that the foundation shall be capable of resisting
- c) The portion of the equipment that requires an integral pad, and the portion(s) that may be mounted on independent foundations
- d) An outline drawing of the equipment showing the expected maximum displacement of electrical terminals and other points of interconnection between the apparatus and other equipment
- e) The fundamental natural frequencies and sampling data
- f) An analysis and description of the probable modes of failure. Maximum working stresses should also be included in the analytical data furnished.
- g) The ductility factors used should be indicated in the analytical data furnished
- h) Satisfactory connections between isolated and nonisolated apparatus should be proposed
- i) A description and results of the dynamic analysis used
- j) A description of the test method that has been used to determine the natural frequencies and results of damping of the apparatus together with the static analysis, when a dynamic analysis is not applicable
- k) A summary of the results of an explanation of the seismic proof test procedures (see ANSIZ24.21-1957 and IEEE Std 344-1987 )

### 6.4 Lightning and switching surge protection

The purpose of this subclause is to describe design criteria and recommend practices that will minimize the adverse consequences of exposure to lightning discharges and switching surges. Effective protection can only be accomplished through a combination of adequate design and proper installation.

#### 6.4.1 Design criteria

The basic design goal for achieving protection from lightning and switching surges shall be that of keeping any abnormal voltage or current, or both, out of the equipment cabinets.

### **6.4.1.1 Basic protection**

All inputs and outputs are required to meet the oscillatory and fast transient surge withstand capability (SWC) tests, as defined in IEEE Std C37.90.1-1989 (see 5.4.1).

### **6.4.1.2 Voltage surges**

Voltage surges can enter the cabinet and cause damage despite the SWC protection provided on inputs and outputs. Equipment failures resulting from such damage should be fail-safe. Logic designs should be such as to minimize the possibility of false or improper operation of field devices. Partial failures that do not disable the equipment but can reduce or eliminate security features, such as error checking in communication circuits, shall be detected and cause the blocking of control outputs to prevent false operations of field devices.

## **6.4.2 Installation criteria**

The basic installation goal for achieving protection from lightning and switching surges shall be to minimize the exposure of all connecting wires and cables.

### **6.4.2.1 Power, signal, and communication circuits**

Power, signal, and communication circuits provide a path through which lightning and switching surges enter equipment. Circuits totally within a protected building can generally be installed without regard to these external effects. These circuits may still be subjected to transients generated by the operation of solenoids and control relays. Circuits that are connected to, or are part of, circuits not within a protected building should be installed in a manner that will minimize exposure.

### **6.4.2.2 Installation constraints**

When installation constraints result in a high degree of exposure to lightning or switching surges, supplementary protection such as spark gaps or surge limiters should be considered (see IEEE Std 422-1986 and IEEE Std 525-1992).

## **6.5 Acoustic interference limitations**

The sound level from any equipment at a distance of 3 ft in any direction shall not exceed 55 dB above the standard reference level with the Type "A" weighted network. The measurements and the weighted network shall be in accordance with ANSI S12.10-1985. The sound level measurements shall be made with a sound level meter that meets or exceeds ANSI S1.4-1983.

## **6.6 Electromagnetic interference (EMI) and electromagnetic compatibility (EMC)**

Manufacturers shall design and test their equipment to ensure that EMI limits are not exceeded, and users shall design and test locations (environments) to ensure that EMC limits are not exceeded. Both manufacturers and users should follow the Code of Federal Regulations, Title 47, FCC Rules Part 15, Subparts A and B [B20] to aid in specifying and applying various techniques which limit equipment and environmental emissions.

Specifically, this reference shall apply to control and data acquisition equipment outside of utility substations, and may also be applied within utility substations. Computer and microcomputer-based equipment are expected to perform their intended functions in substations even when exposed to transient electromagnetic interference. The user should be aware of EMI in substations and either specify the EMI level for guaranteeing proper operation or accept the risk of misoperation in the presence of EMI.

### 6.6.1 EMI limits

Control and data acquisition equipment shall not generate radiated emissions in excess of (1 V/m)/MHz as measured 1 m from the enclosure. Manufacturers shall mechanically and electrically design equipments for emission limits by employing attenuation techniques such as isolation, shielding, grounding, gasketing, filtering, and bonding.

### 6.6.2 EMC limits

Control and data acquisition equipment shall be capable of operating in radiated fields as specified by the user. Information available to date indicates that the average field strength in substations may run in the order of (1 V/m)/MHz. The specified value of (1 V/M)/MHz refers to broadband radiated fields due to station environment, resulting from such things as corona and switching transients. This requirement is not intended to cover narrowband radiated field sources such as electronic test equipment or portable radio transmitters (walkie-talkies). Where such equipment may be used, the field strength is properly expressed as volts per meter at a specified frequency, and different EMC limits may be required (see IEEE Std C37.90.2-1987 ). Should the field strength of a proposed installation exceed this value, the user shall mechanically and electrically design the equipment location for conducting susceptibility limits by using cable shielding and grounding techniques found in the following publications:

- a) IEEE Std 422-1986 for power generating stations
- b) IEEE Std 525-1992 for substations
- c) The equipment manufacturer's guide for site preparation and installation shall be followed at other locations.

#### 6.6.2.1 High radiated emissions

Whenever equipment is to be located in an environment and is susceptible to radiated emissions that are higher than those specified in 6.6.2, then either

- a) The manufacturer should shield from radiated sources with an enclosure that provides the necessary attenuation, or
- b) The user should provide additional structural attenuation

The approach taken should be an economic one that considers the location's configuration, the signal range of interest, and the amount of additional field strength encountered.

#### 6.6.2.2 High magnetic fields

Equipment that is sensitive to magnetic fields should be stored and operated in environments that limit magnetic flux density. Typical storage limitations for magnetic tape and disk units are in the range of  $(50 \text{ to } 70) \cdot 10^{-4}$  tesla.

## 7. Characteristics

This clause defines and discusses general characteristics that are required of the control and data acquisition equipment. These characteristics include reliability, maintainability, availability, security, expandability, and changeability.

### 7.1 Reliability

Mathematically, reliability is the probability that a unit or system will perform its intended function under specified conditions during a specified period of time. For complex equipment, failures will occur on the average at a constant rate throughout the useful life of the equipment. This allows the manufacturer to characterize equipment reliability with a simple figure of merit called mean-time-between-failure (MTBF).

The exceptions to this constant failure rate are a higher, decreasing failure rate, early in the equipment's life, called "infant mortality," and a higher, increasing failure rate, that signals the onset of "end-of-life." These phenomena give a typical plot of failure rate vs. time, a shape known as a "bathtub curve."

Reliability models and predictions may be made by the supplier in accordance with MIL-H-DBK 217D-1991, or as directed by the user. Software tools (e.g., spreadsheets) are available to facilitate these calculations.

Reliability-related design goals for equipment shall be

- a) That infant mortality be eliminated by the supplier before delivery of the equipment to the user
- b) That the MTBF of the equipment be above a user specified, acceptable, lower limit
- c) That end-of-life begin only after a user specified, acceptable usage period
- d) That a single hardware or software failure anywhere in the system shall not result in a critical failure (e.g., false operation of an external device)
- e) That component failures do not propagate throughout the system, increasing the scope of repair and loss of function

The failure modes of equipment, and the effects of these failures shall be formally analyzed by the supplier. The results of these failure modes and effect analysis (FMEA) shall be available for review upon request.

Failure distribution vs. time data for equipment while in the possession of the supplier, and for those field units for which data are available from the users, shall be documented and available upon request.

Manufactured and/or supplier-procured parts and components that can cause a critical or major system failure are subject to these requirements.

## 7.2 Maintainability

Control and data acquisition equipment shall be maintainable on-site by trained personnel according to the maintenance strategy specified by the user. Requirements for training, documentation, spares, etc., shall take the user's organization and geography into account.

The most common repair strategy is for the supplier to train the user's personnel to identify and replace failed modules on-site from the user's stock of spare modules. These may then be either returned to the supplier for repair or repaired to the component level at the user's maintenance facility. If on-site service by the supplier is necessary, it is most likely to be required for failures of complex computer equipment.

The supplier shall, upon request, be required to provide as part of the system proposal, a list of test equipment and quantities of spare parts calculated to be necessary to meet the specified availability and maintainability requirements. In establishing the quantities of spare parts, the supplier shall consider the time required to return a failed component (field and/or factory service) to a serviceable condition.

The maintainability of equipment is reflected in a figure of merit called mean-time-to-repair (MTTR). The MTTR values used in the supplier's availability computations shall be based to the maximum extent possible upon maintenance experience.

MTTR is the sum of administrative, transport, and repair time. *Administrative time* is the time interval between detection of a failure and a call for service. *Transport time* is the time interval between the call for service and on-site arrival of a technician and the necessary replacement parts. *Repair time* is the time required by a trained technician, having the replacement parts and the recommended test equipment on-site, to restore nominal operation of the failed equipment.

Unless otherwise specified by the user, the following values shall be used in availability calculations:

Administrative time	0.0 h
Transport time	0.5 h

When insufficient maintenance data has been accumulated to provide MTTR values, then the appropriate segments/procedures as defined in MIL-STD 471A-1978 may be used.

Provisions to enhance the maintainability shall include the following:

- a) Useful training and documentation, directed toward maintenance requirements and techniques (see clause 10.)
- b) Equipment self-tests, diagnostics, and trouble shooting procedures to identify failure or malfunction to the optimal field-replaceable module level
- c) Readily accessible test and/or disconnect points, to facilitate fault isolation. Placement of components on cards shall allow access for test probes and connectors.
- d) Physical provisions to preclude improper mounting of modules, including interchange of modules of a same or similar form that are not interchangeable
- e) Provisions (e.g., labels) to facilitate identification and proper mounting of units or modules
- f) Identifying, orienting, and aligning provisions for cable and connectors
- g) Location and/or guarding of adjustment points such that adjustments will not be disturbed inadvertently
- h) Location, guarding, and/or labeling of manual controls to avoid dangerous voltages or other hazards
- i) Provision for connecting external I/O simulation equipment
- j) Provision of extender cards for card cage mounted circuit cards

### 7.3 Availability

Availability is defined in the following as the ratio of uptime to total time (uptime + downtime):

$$A = \text{uptime}/(\text{uptime} + \text{downtime})$$

and is normally expressed as a percent (of total time).

Downtime normally includes corrective and preventive maintenance. When system expansion activities compromise the user's ability to operate apparatus via the system, this may also be included in downtime.

Typical availabilities achievable by nonredundant commercial grade equipment range from 99.99%, for simple devices, to approximately 97% for complex, computer-based subsystems. Proper use of redundant configurations with automatic failover can provide an overall availability of primary system functions of 99.9%.

The availability level required, and the planned maintenance strategy, shall be specified by the user, requiring suppliers to provide supporting predicted availability calculations in their proposals.

An availability test of from 30 to 90 days is often specified prior to acceptance of a system. Operating and maintenance records shall be kept and used to prove the predicted, and to support the achieved availability computations (see 9.7).

For design analysis, and to determine the prediction of availability for subassemblies and units, the following equation utilizing MTBF and MTTR shall be used:

$$A_p = \text{MTBF}/(\text{MTBF} + \text{MTTR})$$

where

$A_p$  is predicted availability

Equations for modeling complex designs shall be formulated by the supplier in accordance with MIL-H-DBK 217D-1991, as discussed in 7.1. Use of the equations associated with parallel redundant components (or subsystems) are valid under the following conditions:

- a) Failure of parallel elements are independent. Component failures do not propagate failures of other components.
- b) Sufficient repair turnaround and standby replacement parts are available to handle multiple simultaneous failures.

The impact of the outage of each system element or function on the availability of the total system shall be mutually agreed upon between the user and the supplier.

Availability test results shall be calculated separately for major system components, (e.g., central computer system vs. RTUs). Since these components may have a varying impact on the usefulness of the system as a whole, different definitions of downtime are applicable.

Major component downtime shall be defined to reflect the proportional significance of the equipment that is down. For example, downtime for the data acquisition system could be defined as the sum of the downtime for all RTUs divided by the total number of RTUs. At the master station, downtime should not include malfunctions in peripheral devices that do not detract from the functional capabilities of the master station as a whole (e.g., printers and tape units).

## 7.4 System security

System security (of operation) is defined as the ability to recognize an inappropriate or undesirable operation or condition in such a fashion that causes an appropriate alarm, a non-operation, or both.

Security of operation considerations are divided into the following three areas:

- a) Operating practice and procedures
- b) Communication security
- c) Hardware and software design

### 7.4.1 Operations security features

Security features comprising operating practice and procedures include the use of function and operating checks (manual and/or automatic). Function and operating checks may include:

- a) Analog reference points (0 and 90%)
- b) Control function check (loop-back)
- c) Scan function check (loop-back)
- d) Poll function check
- e) Logging function check
- f) Queue overflow alarms
- g) Diagnostic aids
- h) Calibration checks
- i) Logging of all operator actions, including whether the equipment completed the requested action
- j) Tagging of out-of-service control points at the user interface

- k) Use of an RTU local/remote switch, with feedback to a status point, to disable all control actuators while an RTU is being serviced

Equipment designed for remote control of power system devices shall use both a select-before-execute user interface (UI) sequence and a checkback-before-operate communication sequence for control operations.

The UI sequence shall provide visual feedback of the selection to the user, so the user can verify that the system has interpreted the selection correctly before executing the control function.

The communication sequence checkback message shall be derived from the RTU's point selection hardware, and not be just a simple echoing of the received select message. This allows the master station to verify not only that the communication was error free, but also that the RTU's I/O hardware and software acted correctly in interpreting the selection.

In order to provide maximum security against random channel noise being interpreted as a select/execute sequence at an RTU, the following safeguards should be incorporated:

- a) The communications protocol shall have a very effective redundancy check code (this is necessary, but not sufficient, security)
- b) There shall be a relatively short timeout between the select and operate steps
- c) The next master station message following the select shall be the execute
- d) The complete point identification shall be contained in the select, checkback, and execute messages, which shall be fully compared before the control operation is executed
- e) If any of the above checks fail, the control sequence shall be reset immediately, and a new select message shall be required to restart it
- f) Both the master station and RTU shall enforce the above rules.

The communication checkback sequence may be performed either concurrently with the control selection sequence at the UI, or after the selection sequence has been completed. When performed concurrently, the selection of a point for control shall cause the select message to be transmitted to the RTU. Upon successful receipt, the RTU shall arm itself for control, generate the checkback message, and transmit it back to the master station. A valid checkback message shall result in visual selection feedback to the user, who can then choose to either execute or cancel the control function.

This type of operation requires a longer select/execute timeout at the RTU, and will either violate the execute-next rule, or will stop scanning on that channel until the user responds with an execution or cancellation.

When the UI sequence and communication sequence are performed sequentially, the selection of a point for control should cause the master station to display a visual indication of that selection for verification.

In this type of operation, the user's verification of selection does not come from the RTU, but all other security features may be fully implemented.

The user may then execute the control function. Status and data scanning should then be interrupted, and a select message sent to the RTU.

The RTU shall then arm the control function and return a checkback message. The checkback message shall be checked by the master station, and an execute message sent automatically to the RTU. If this execute message is received as valid, the RTU shall execute the command and return an acknowledgment that the function has been performed.

#### **7.4.2 Communication message security**

Communication security features include:

- a) The design goal that an error in a message shall not result in a critical failure of the system.
- b) Alarming the failure of an RTU to respond to a message within a specified number of automatic retries.
- c) Ensuring that communication channel error control, in concert with the communication protocol and line discipline, reduce the probability of acceptance of messages received with errors to less than 1 in  $10^{-10}$  when the channel bit error rate is 1 in  $10^4$ .
- d) Verification of the proper operation of communication channels on a regular basis.
- e) Counting, and periodically logging, communication errors on a per-channel basis.
- f) Ensuring that no two RTUs with the same address share the same party line or switched communication channel.
- g) Ensuring that each RTU communication channel supports only one communication protocol.

### 7.4.3 Hardware/software security features

Security features comprising hardware and software design include the following:

- a) Power supply protection—overcurrent, over/undervoltage
- b) Automatic initialization and restart
- c) Equipment self-check with alarm
- d) Watchdog timer(s) with alarm
- e) Automatic failover with alarm
- f) Fail-safe operation
- g) Non-volatile station address retention in RTUs

## 7.5 Expandability

Expandability is the ease with which new points and/or functions, or both, can be added to the system, and the amount of downtime required.

Expansion point types are defined as spare point, wired point, and *space-only*. *Spare point* equipment is equipment that is not being utilized but is fully wired and equipped. *Wired point* is the capacity for which all common equipment, wiring, and space are provided, but no plug-in point hardware is provided. *Space-only point* is the capacity for which cabinet-space-only is provided for future addition of equipment and wiring.

Expandability limitations may include, but are not restricted to, the following:

- a) Available physical space
- b) Power supply capacity
- c) Heat dissipation
- d) Processor throughput and number of processors
- e) Memory capacity of all types
- f) Point limits of hardware, software, or protocol
- g) Bus length, loading, and traffic
- h) Limitations on routines, addresses, labels, or buffers
- i) Unacceptable extension of scan times by increased data (given bit rate and protocol efficiency)

## 7.6 Changeability

Changeability is defined as the ease with which system, RTU, and point data base parameters may be changed at both the master station and RTU. Parameters that shall be easy to change include the following:

- a) Operating parameters
- b) Configuration and setup parameters

The supplier's documentation (see 10.3.2) shall contain the step-by-step process for subclauses 7.6.1 through 7.6.3.

### **7.6.1 Operating parameters**

Operating parameters must be easily changed by the system user. They include, but are not limited to the following:

- a) RTU on/off-scan
- b) Point on/off scan
- c) Point tags on/off
- d) Manually entered values
- e) Point alarm limits
- f) Point deadband values
- g) IED parameters

### **7.6.2 Configuration and setup parameters**

Configuration and setup parameters must be easily changed by an authorized system engineer, but shall be protected against being changed by the users. They include the following:

- a) Configuration password
- b) Major/minor alarm conditions and actions
- c) User-definable calculations
- d) Definition of a new RTU
- e) Communication port and/or station address assignments of RTUs
- f) Addition and/or rearrangement of an RTU's points
- g) Correspondence of status points to control points
- h) Point and state descriptions, for presentation to the system user
- i) Point scaling factors, for conversion of data to engineering units
- j) Output relay dwell times

### **7.6.3 Changeability limitations**

Changeability limitations may result from, but are not limited to the following:

- a) Inability to make master station and RTU data base changes on-line from the master station
- b) Storage of parameters in memory (e.g., ROM) that is not modifiable in-circuit
- c) Restrictions caused by data base structure
- d) Hardware/software compatibility
- e) Hardware limitations
- f) Software operating system limitations
- g) Restrictions caused by use of IEDs

## **7.7 Spare capacity**

Spare capacity is defined as the additional capacity that can be added to the master station.

### **7.7.1 Main memory**

A requirement of no less than 50% unused main memory initially will allow enough expansion for new functions, enhancement of existing functions, and growth of the power system and the equipment that needs to be monitored. Computer documentation shall also be consulted to determine how much main memory capacity can be expanded over and above the capacity initially installed. As a minimum, it shall be possible to double the initial capacity with the addition of memory modules.

### **7.7.2 Auxiliary memory**

A requirement of no less than 50% spare disk capacity initially will allow for moderate expansion. Computer documentation shall also be consulted to determine how much disk capacity can be expanded over and above the capacity initially installed. As a minimum, it shall be possible to double the initial capacity with the addition of disk units.

## **8. Marking**

The control and data acquisition equipment and major subassemblies shall be suitably marked as necessary for safety and identification.

### **8.1 Identification**

Each type of equipment shall be identified so that it can be easily correlated with the documentation. The means of identification shall be uniform throughout the system, and it may include color coding, labeling, and part number. The identification mark shall be permanently affixed to the part that it identifies. Consideration shall be given to using bar code labels to identify the equipment and subassemblies.

### **8.2 Nameplates**

Each separate unit of the system shall be furnished with nameplates bearing the following information:

- a) manufacturer's name
- b) address
- c) identification reference
- d) rated voltage (ac or dc, or both)
- e) rated continuous current
- f) rated frequency (if necessary)

Nameplates shall be legible at a distance of approximately 1 m.

### **8.3 Warning**

Warning signs or safety instructions shall be applied where there is a need for general instructions relative to safety measures (e.g., supply circuit).

## **9. Tests and inspections**

The purpose of this clause is to describe the tests and inspections recommended to ensure that control and data acquisition equipment will perform reliably and correctly according to the user's technical specifications. Users shall specify all tests to be performed. Test requirements shall cover, as a minimum, all critical portions of the specification, especially functional and design requirements. Tests shall be required to be conducted by user and supplier. Test results and all deviations from test plans shall be required to be documented.

## 9.1 Stages of tests and inspections

The test and inspection process requires that various functions of the equipment be tested or verified during one or more stages in the production and installation cycle of the equipment. These stages and appropriate tests are illustrated in table 13.

Across the top of the table are shown the four major classes of tests and inspections, being interface, environmental, functional, and performance. The three stages of testing and inspections, being certified design, factory and field, are shown along the left-hand edge of the table. The specific tests and inspections in each class are listed in the body of the table, below the class heading. Tests listed without notation are recommended for all applications at the stage in which they can be most economically performed.

Tests marked with an asterisk are optional and are performed only when specified by the user. Certified design tests on equipment can be accepted at the user's discretion.

### 9.1.1 Certified design tests

These are tests performed by the supplier on specimens of a generic type of production model equipment to establish conformance with its design standard. The conditions and results of these tests shall be fully documented and certified.

### 9.1.2 Factory tests and inspections

This stage includes the inspection and approval of interface drawings prior to fabrication of the equipment and all functional tests and inspections performed on the actual equipment to be supplied to the user prior to the shipment of that equipment from the supplier's facilities. The factory tests shall be a highly structured procedure designed to demonstrate, as completely as possible, that the equipment will perform correctly and reliably in its intended application. Factory tests may also include tests to verify some or all of the results of the certified design tests.

### 9.1.3 Field tests and inspections

Field tests and inspections are performed on the equipment after it has been shipped from the supplier's facilities. These include pre-installation inspections and tests to ensure the equipment has not been damaged during shipment and post-installation tests to verify the equipment performs its functions reliably and correctly.

## 9.2 Interface tests and inspections

These tests are designed to demonstrate that the various mechanical and electrical interfaces to the equipment are in accordance with applicable portions of clause 5., together with other applicable parameters called out in the user's specifications. For the most part, these interface parameters can either be demonstrated during factory tests or accepted on the basis of certified design tests.

**Table 13— Test stages and classes of tests**

Tests stages	Classes of tests			
	Interface tests and inspections	Environmental tests and inspections	Functional tests and inspections	Performance test and inspections
Certified design tests	Power input SWC Dielectric	Temperature Humidity Acoustic*	—	—
Factory tests and inspections	Mechanical Power source SWC Dielectric	Temperature Humidity Acoustic Altitude/pressure Dust EMI EMC Shock and vibration	I/O point checkout Communications User interface Special functions	Loading Data acquisition- Control Computer & disk stability Maintainability Expandability
Field tests and inspection	—	—	I/O point checkout Communications User interface User interface Special functions	Availability

\*Optional tests performed only when specified by the user.

**9.2.1 Mechanical**

Mechanical characteristics (e.g., materials, workmanship, dimensions, fabrication techniques, and finishes) shall be verified through visual inspections and comparisons with applicable drawings.

**9.2.2 Electrical**

These tests include all those to be performed on electrical interfaces to the equipment, with the exception of those related to the functional performance of the equipment.

**9.2.2.1 Power source**

The equipment shall be tested to demonstrate the proper operation of the equipment throughout the range of specified power source parameters.

**9.2.2.2 Surge withstand capability (SWC)**

All inputs and outputs to the control and data acquisition equipment, unless otherwise specified, shall be tested to verify conformance to IEEE Std C37.90.1-1989 . In conducting the oscillatory and fast transient SWC tests, the RTU shall be in operation communicating with a master, and connected to signal inputs and dummy device outputs. Application of the SWC tests shall not damage the RTU nor cause a false RTU operation or data corruption (see figure 8).

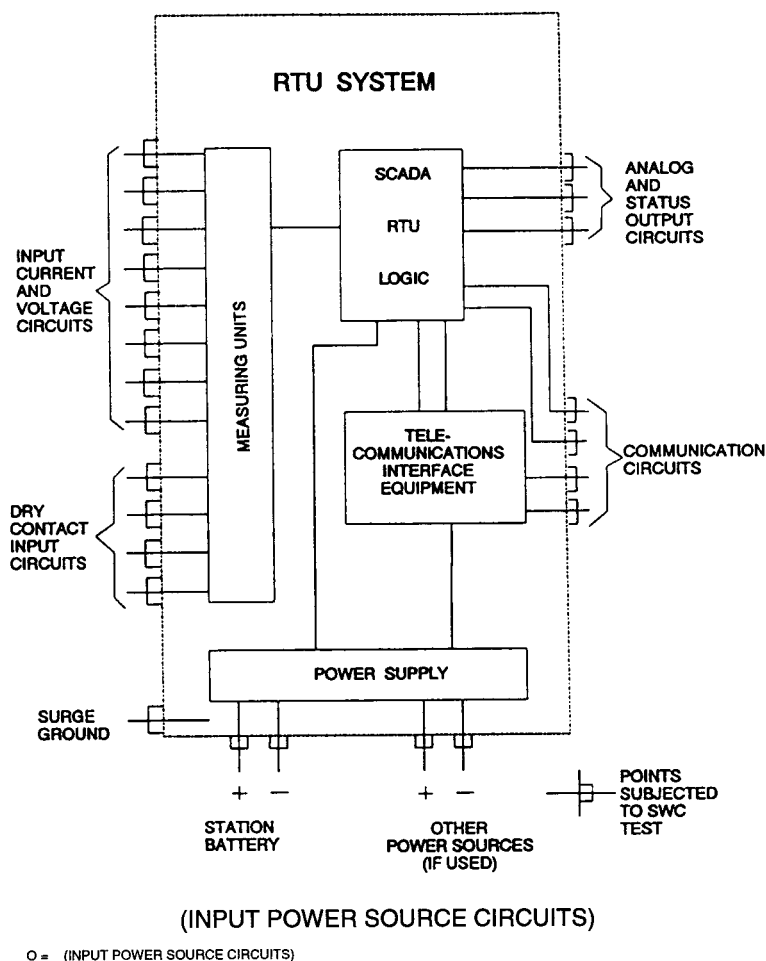

**Figure 8— Typical power source circuits**

### 9.2.2.3 AC dielectric tests

The control and data acquisition equipment shall be capable of withstanding a high-potential test. The purpose of this test is to verify the dielectric strength of the insulating materials used in those parts of the equipment exposed to hazardous voltages.

The test shall be applied between all incoming and outgoing terminals and chassis ground. During the test, communication, power supply, status and data input, and output equipment that are not expected to withstand the test voltage shall be disconnected from the wiring leading to the terminals. Control output end elements, such as interpose relays or solid state switches, should not be disconnected.

Equipment inputs and outputs rated 60 Vac or less shall be capable of withstanding a 60 Hz high-potential test for 1 min at 500 Vac rms. Equipment connected to inputs and outputs rated above 60 Vac (but not over 600 Vac) shall be capable of withstanding a 60 Hz high-potential test for 1 min of 1000 Vac plus twice rated voltage, within a minimum of 1500 Vac rms.

#### **9.2.2.4 DC dielectric test**

All control and data acquisition equipment that is to be connected to a station control battery shall be capable of withstanding a dc high-potential test (1500 V plus twice rated voltage). The purpose of this test is to verify the dielectric strength of the insulating materials used in these devices. The intent is to ensure that failures will not occur in such a manner as to degrade the integrity of other critical equipment, such as protective relays, that utilize the common battery.

The test shall be applied for not less than 1 min between all incoming and outgoing terminals and chassis ground. Examples of equipment that shall be subjected to this test include, but are not limited to, power supplies, status input devices (optical isolators, relays, etc.), and control output devices. All devices may be tested on a subassembly basis with supervisory or automatic equipment logic wiring removed. All wiring from the device to the terminal strips provided for user field wiring, and any other devices that may be provided, such as fuses and surge arresters, shall be included in the test.

### **9.3 Environmental tests**

These tests are designed to demonstrate that the equipment will perform correctly and reliably while exposed to the applicable environmental parameters described in clause 6., together with other applicable parameters called out in the user's specifications. The results of certified design tests are usually sufficient to demonstrate that the equipment will operate reliably and correctly within a specified environment. The user may require the supplier to perform factory tests on the equipment to demonstrate that it will indeed perform correctly under the specified environmental conditions. Equipment in environmental tests should be operating with realistic inputs and outputs.

The environmental parameters and testing requirements specified by the user should be limited to the worst case conditions that can be realistically anticipated in the location where the equipment will ultimately be installed.

#### **9.3.1 Physical**

The equipment shall be tested to verify that it operates correctly in the following physical environments described in 9.3.1.1 through 9.3.1.5.

##### **9.3.1.1 Temperature**

To test the equipment within the specified temperature range (see 6.1.1), it shall be placed in an environmental test chamber where it can be operated for a specified period at both the low and high ends of the range, and cycled between them. Calibration and accuracy checks shall be made throughout the range.

##### **9.3.1.2 Humidity**

Humidity tests (without condensation) shall be performed in conjunction with the temperature test (see 9.3.1.1). Humidity test data shall include the humidity ranges tested at each temperature.

##### **9.3.1.3 Altitude**

Altitude tests shall be performed by placing the equipment in a pressure chamber and adjusting the air pressure to the equivalent of the specified altitude.

##### **9.3.1.4 Dust**

Testing shall consist of inspection to determine whether or not the equipment is properly sealed to prevent intrusion of dust.

### **9.3.1.5 Acoustic**

Acoustic interference testing shall be done in accordance with the methods outlined in ANSI StdS12.10-1985 . Equipment being tested shall meet the standards set forth in 6.5.

### **9.3.2 Electromagnetic**

#### **9.3.2.1 Electromagnetic interference (EMI)**

Tests shall be conducted to establish that the equipment does not produce either conducted or radiated electromagnetic interference in excess of the level defined in 6.6.

#### **9.3.2.2 Electromagnetic compatibility (EMC)**

The equipment shall be tested to demonstrate that it will operate satisfactorily in spite of the levels of conducted and radiated interference as defined in 6.6.

### **9.3.3 Shock and vibration**

Tests shall be performed to verify functional performance of the equipment when subjected to shock and vibration as defined in 6.2.

## **9.4 Functional tests**

Functional tests shall be designed to ensure that the equipment performs its functions reliably and correctly. They are performed during the factory or field test stages, or both. Preliminary testing should be performed by the supplier before verification by the user. For many applications and types of equipment, successful factory tests will be a sufficient basis for acceptance of the system by the user. For more complex applications or systems, additional tests in the field may be required to fully verify correct and reliable performance.

### **9.4.1 I/O equipment checkout**

All I/O equipment to be supplied shall be tested during factory tests to demonstrate that it performs its functions correctly, accurately, and reliably. These tests shall be performed with equipment that simulates the actual equipment to be monitored or controlled.

### **9.4.2 Communication**

The communication tests shall demonstrate proper operation of all aspects of the equipment's communication capability, including modems, security checking, and message protocols. The data modems or signaling equipment shall be exercised to verify that they operate correctly and reliably on the type of channel for which they are designed. The tests shall be conducted under conditions that duplicate as closely as possible the specifications for the channel including simulated channel noise, common mode SWC tests, communication failures, and recovery. Provisions shall be made to log communication outages and update communication statistic displays where these features are provided.

The communication tests shall exercise all message protocols and formats to which the equipment is designed to respond. The tests shall also demonstrate that any error detection or correction capabilities function properly and that the equipment does not respond to erroneous commands.

### 9.4.3 User interface (UI)

Comprehensive user interface tests shall be performed to verify the correct functional operation of all user interface hardware and software. All indications and displays shall be verified to ensure that they correlate with the correct I/O equipment, and all user controls shall be checked to ensure that they result in only the correct sequence of operations.

### 9.4.4 Special functions

When the equipment supplied is to perform functions tailored expressly to the user's application (e.g., closed loop control), these functions shall be checked during the appropriate test stage. It is often necessary to perform these tests in the field, after the equipment has been adjusted to the parameters of the installation.

## 9.5 System performance tests

The performance of all critical parameters of the equipment (e.g., communication, peripherals, user interfaces, I/O processing, and CPU) shall be measured under various loading conditions or scenarios. System performance shall be measured as early in a project as possible to identify any system weaknesses. This will allow the user and supplier an opportunity to resolve problems in a timely manner.

The loading scenarios shall simulate the following:

- a) normal activity-initial system
- b) heavy activity (disturbance loading defined by user)-initial system
- c) normal activity-fully expanded system
- d) heavy activity (disturbance loading defined by user)-fully expanded system
- e) communications failures or high noise conditions such as high noise on an entire microwave system

Loading conditions should be determined by analyzing worst case conditions experienced by the user and the worst possible condition likely to happen in the future over the life of the system. Table 14 is provided as a guide. The selection of changes in scanned status and analog input data is based upon research and studies of the behavior of power system data under normal and heavy activity conditions (see [B21]).

The measurements for performance assume that all functions of the system have been individually verified by functional tests and that the total system is ready to be evaluated.

If actual system inputs are not available, they shall be simulated with special hardware or software. For a meaningful test, these inputs shall include the following:

- a) Simulated RTU inputs (alarm contacts, power circuit breakers, analog inputs, transformers, etc.) into the modem
- b) Simulated message data structures from the RTUs into the master station communication interfaces
- c) Simulated data links to other computers, specifying the amount, type and frequency of data to be transferred
- d) Simulated user interfaces such as mapboards and chart recorders
- e) Other simulated inputs (generator data, etc.)

**Table 14— System performance tests \***

<b>Input</b>	<b>Activity cycle</b>
<b><u>NORMAL ACTIVITY</u></b> Each user Status input Analog inputs	1 CRT request/minute 5 changes/hour 1% of all analogs change/scan
<b><u>HEAVY ACTIVITY</u></b> Each user Status inputs Analog inputs	1 CRT request/15 seconds 15% changes/scan 40% of all analogs change/scan

\*Values given are for example only. It is recommended that the user select values that represent the user's system characteristics and operating procedures.

Manual operation sequences to be performed during tests shall be described in detail to provide a repeatable test scenario and a way to measure improvements in performance (e.g., five people requesting one-line diagrams and two people requesting menu displays simultaneously). Test steps should simulate all normal user operations.

Response performance shall be measured in seconds. All measurements shall be recorded for analysis after the tests. Software utility programs are available from most system suppliers for finding CPU utilization and loading (e.g., feature of the computer operating system or a separate program available from computer manufacturer, or both) and if used by supplier the system loading of the programs shall be provided to user with proof. Automatic measurement of other test parameters can be done by special purpose software.

### 9.5.1 Data acquisition performance

Data acquisition subsystem performance measures the following:

- a) The time for a status change or analog change at the RTU to be displayed to the user at the master station (e.g., CRT, logger or mapboard).
- b) The time to query all RTUs on a per channel basis

A cyclic status point input of 2.1 times the system RTU scan rate can be used to detect a missed scan due to overloading. The status input simulator should be connected to an input of one RTU. The alarm associated with the toggled input shall appear on the logger with a time tag of approximately twice the scan rate. A system overload causing an extension of the scan cycle is obvious from the printout because one or more status changes is missed.

### 9.5.2 Control performance

Control performance measures the elapsed time between a control request by a user at the master station and the control output contact closure at the RTU. This test shall also be performed in the field. The field test will provide realistic measurements, using user installed RTUs and communication facilities.

### 9.5.3 User interface performance

The user interface performance is a measure of the response time to satisfy user requests for information. To measure display response time, measure the time from the instant a request is made until the result of the request is completely displayed on a CRT screen, printed on a logger, or shown on a mapboard. Different classes of displays (one-line diagrams, alarm summaries, menus, tabular, etc.) may have different display response times due to the amount of data to be gathered and computations required before a display request can be completed.

### **9.5.4 Computer and disk performance**

The performance measuring device should be a computer program temporarily added to the system to operate at the lowest priority. The objective of using a low-priority program is to measure what otherwise is unused or idle capacity. The impact of various loads on idle capacity is the information that is to be obtained and analyzed. The program should accumulate time for central processor usage. In addition, it should print a time-tagged message every time it is called. These measurements can help locate software bottlenecks and thus improve system performance.

#### **9.5.4.1 Computer and disk utilization or loading**

Measurement of CPU utilization gives the user an idea of how much spare CPU capacity remains in the system. Monitoring programs from the computer manufacturer, operating system supplier, or even third party suppliers who specialize in this area can provide these programs to monitor CPU utilization.

To measure computer usage, a count should be advanced for each basic time interval (e.g., a millisecond) that the program is using the central processing unit. The basic time interval should be selected based upon the speed of the computer and the size of software modules typical of the system under test.

The basic time interval is one in which some useful computation could be performed. Neither too small nor too large a basic time interval will be of use in performance measurement. The idle time of the computer is assessed by comparing the count of the number of basic time intervals recorded by the program to the total period of the test.

Measurement of disk utilization gives the user an idea of how much spare disc capacity remains in the system. The impact of the various loads on idle capacity is the information that is to be obtained and analyzed. The program should accumulate time for disk usage. This program should exercise the disk interface to access the unused capacity and to attempt to compromise total system performance. If the disk interface has unused capacity, the lowest priority program should be able to read/write from/to the disk. Counting the number of completed vs. attempted disk accesses of known size during the test interval will give a measure of the available bandwidth.

The program should also try to dominate the disk interface by writing or reading large blocks of data. Restrictions, if any, used by the supplier in his design should be honored in the design of this computer program. The objective of this test is to see if a low-priority program can delay higher-priority tasks by excessive disk activity.

Disk spare capacity, defined in 7.7.2, shall be verified.

Main memory spare capacity, defined in 7.7.1, shall be verified.

#### **9.5.4.2 Computer link response time**

Computer to computer link response times should be measured and evaluated during performance tests under varied loading conditions.

#### **9.5.4.3 Computer LANs response time**

LANs that connect application computers together should be measured and evaluated during performance tests under varied loading conditions.

#### **9.5.4.4 Computer reconfiguration, power fail, and restart tests**

On master stations with redundant equipment, reconfiguration tests should be performed to confirm the ability to failover from one CPU to another (reconfigure the real-time database) and to switch peripheral equipment to the primary system, the secondary system, or off-line (i.e., out-of-service).

Power fail tests measure the time to recover from a complete or partial power failure until the system is fully operational.

Because normal maintenance procedures and equipment failure cause downtime of the master station, restart tests are to assure the system will recover in a timely manner. Existing data shall consist of all scanned and manually entered data (i.e., power system tags, manual overrides, limit changes, etc.). Downtime of the system or parts of the system should be measured during these tests to confirm the length of these outages can be tolerated by the user.

The time required to load a system from mass storage and initiate operation should be measured. This time should be less than the acceptable system outage time.

## 9.6 Stability test

A test to verify stability of the system over a continuous period shall be conducted at the supplier's facility with the system configured as it will be used in the field. Typical duration of 100 h to 400 h shall suffice. The test shall include periods of unattended operation, operation under normal activity conditions, and operation under heavy activity conditions. All functions shall be operating with simulated inputs throughout the test.

## 9.7 Availability test

The user shall require an availability test to be run after the system is installed and placed in operation (see 7.3). An availability test takes place over a specified length of time during which the equipment shall operate correctly and reliably for at least a specified percentage of that time. The length of the test shall be sufficient to verify that the equipment can be expected to perform its intended functions reliably and correctly over its intended lifetime.

The availability test shall be run under conditions mutually agreeable to the user and supplier. In general, the supplier shall be responsible for making the necessary repairs. Downtime should not include delays over which the supplier has no control.

Availability tests are typically performed over a period of thousands of hours. This is followed by analyzing the number and types of failures, and their effects on system operation. The test time should be selected so that the total number of device operating hours for each type of system-critical device is representative of the predicted MTBF for that device to obtain statistically significant failure data. Specific rules for accumulation of uptime, downtime, maintenance time, and administrative time shall be agreed upon before the test (see clause 7.).

## 9.8 Maintainability test

The user shall require a maintainability test to be run to evaluate the supplier's design, documentation, training, and recommended spare parts. Maintainability will directly affect the availability of the SCADA system and therefore the reliability of the power system (see 7.2). Computer hardware maintenance and long term repair support are difficult to evaluate without actual experience. Discussions with other utilities regarding their experience is one way to acquire a certain degree of knowledge about the maintainability of specific equipment and systems.

Software, database, and display maintainability is also critical to the successful operation of a SCADA system. Tests to be witnessed should include the following:

- a) System generation tests (measure time to complete, and amount of manual intervention required)
- b) Database maintenance:
  - 1) Adding an alarm point (time to make operational) should be demonstrated
  - 2) Deleting or changing text on an alarm point should be demonstrated
  - 3) Changing an analog scale factor should be demonstrated
- c) Display maintenance

- 1) A new one-line diagram should be added and linked to the database (a specific example in the specification should be provided)
- 2) A line and power circuit breaker bay should be added to an existing one-line diagram including analogs, tags, etc.
- d) Equipment maintenance
  - 1) A console CRT should be replaced
  - 2) A modem should be replaced
  - 3) A disk drive should be replaced

### 9.9 Expandability tests

Expansion capability of a new system shall be analyzed and may be tested (see 7.5). For example

- a) RTU I/O point expansion (both hardware and software changes required)
- b) Master station expansion
  - 1) Peripherals, disk space, memory
  - 2) CPU capacity (percent utilization)
  - 3) User interface (CRT additions, mapboard point expansion)
  - 4) Database and display expansion

### 9.10 Documentation verification

The final phase of the testing program is to verify that the documentation being supplied is an accurate description of the equipment, including all corrections resulting from the tests. Final issue of completed documentation shall be provided as soon as practical after shipment and acceptance of the equipment.

## 10. Documentation

The documentation for control and data acquisition equipment shall cover five basic areas as follows:

- a) Design
- b) Installation
- c) Operating instructions and records
- d) Maintenance instructions and records
- e) Test

In general, all final documentation provided by a supplier shall reflect the actual equipment as accepted by the user, and all subsequent equipment changes shall be recorded as document revisions by the user.

If users desire to have the information on reliability as described in clause 7., they shall collect information on failures and repairs for all subassemblies. This data on operating performance shall then be periodically provided to the supplier.

Content requirements for each type of standard document are defined in subsequent subclauses, as well as suggested practices for the user of this standard. Style, format, and publication requirements are excluded from this standard. The following references are recommendations for abbreviations and symbols: ANSI/ISO5807-1985 , ANSIIY14.15-1966 , IEEE Std C37.2-1991 , IEEE Std 91-1984 , IEEE Std 91a-1991 , IEEE Std 200-1975 , IEEE Std 280-1985 , IEEE Std 315-1975 , and IEEE Std 315a-1986 .

Documentation described in subclauses 10.1 through 10.5 may be subject to user review or approval. Documentation may be structured in alternate fashion, but shall cover all five areas. The documentation may be supplied in one or

more of several forms—printed, computer stored, or electronic media. In the latter case, the supplier shall either identify or supply the supporting word processing software used to prepare the documentation.

## 10.1 Design

Design documentation is the responsibility of the supplier. For example, expansion methods for adding points to hardware assemblies and software programs or tables shall be described and illustrated. Block diagrams shall be included to describe control and data acquisition equipment and external equipment. Layout and wiring drawings shall also be included to define external interconnection needs at each facility. Text, photographs, and illustrative material shall accompany these drawings in sufficient detail so that functional performance and design may be readily understood. For example, functional block diagrams and explanatory text shall be used to describe each major assembly and software program contained in the equipment configuration. A document describing the communication process between the master station and the RTUs shall be provided (see IEEE Std 999-1992 for an example). The supplier shall be responsible for providing outline drawings, mounting requirement details, customer connection details, environmental requirements, size, weight, and any other information needed for the user to prepare installation documentation.

## 10.2 Installation

Installation documentation is the responsibility of both the supplier and user and shall define the following:

- a) Electrical power, data, control, and communications interface wiring procedures
- b) Floor, rack and shelf mounting, drilling, and bolting methods necessary to secure the equipment in place
- c) Safety precautions or guards
- d) Grounding and bonding procedures
- e) Clearances for access and ventilation
- f) Testing and alignment methods
- g) Weatherproofing, dustproofing, and other environmental procedures
- h) Other procedures needed to properly install the equipment

## 10.3 Operating instructions and records

Instruction information shall be developed for operating personnel who use the control and data acquisition equipment.

### 10.3.1 Supplier operating instructions

The supplier shall publish instructional information defining the equipment and how it shall be operated. This instructional information shall consist of a general description of the equipment configuration provided and shall state its intended use and its major performance characteristics. Whenever a user interface such as a console, benchboard, indicating/control panel, or printing device is involved, the operational documentation shall detail in step-by-step fashion the operational sequences required to use these interface devices. Adequate illustrative material shall be included to identify and locate all control and indicating devices.

### 10.3.2 User operating instructions and records

The equipment supplier shall publish operating procedures defining the system and include user detailed instructions and responsibilities. These user instructions shall be based on the supplier's instructional information and the nature of the system being monitored and controlled. Procedural instructions, that state routine and emergency procedures, safety precautions, and quantitative and qualitative limits to be observed in the starting, running, stopping, switching, and shutting down of control equipment, shall be included. Whenever operating procedures or adjustments are to be performed in a specific sequence, step-by-step instructions should be stated.

### **10.3.3 Records**

Records shall be prepared by both operating and maintenance personnel to support the availability/reliability calculation defined in 7.1, 7.2, and 7.3.

## **10.4 Maintenance instructions and records**

Maintenance documentation for personnel skilled at the electronic technician level shall be developed and provided by the supplier, and shall include the following information listed in subclauses 10.4.1 through 10.4.4.

### **10.4.1 Performance information**

This information shall include a condensed description of how the equipment operates (derived from 10.1) and a block diagram illustrating each major assembly and software program in the configuration. Message sequences, including data and security formats for each type of message, shall be included in the condensed description and illustrated whenever such messages are used between stations, or locally at a station. The operational sequence of major assemblies and programs shall be described and illustrated by functional block diagrams. Detailed logic diagrams and flowcharts shall also be provided as necessary for troubleshooting analysis and field-repair actions.

### **10.4.2 Preventive maintenance instructions**

These instructions shall include all applicable visual examinations, software and hardware test and diagnostic routines, and resultant adjustments necessary for periodic maintenance of control equipment. Instructions on how to load and use any test and diagnostic program, and any special or standard test equipment shall be an integral part of these procedures.

### **10.4.3 Corrective maintenance instructions**

These instructions shall include guides for locating malfunctions down to the spare parts replacement or field-repair level. These guides shall include adequate details for quickly and efficiently locating the cause of an equipment malfunction, and shall state the probable source(s) of trouble, the symptoms, probable cause, and instructions for correcting the malfunction. These guides shall explain how to use any on-line test and diagnostic program and any special test equipment if applicable.

Corrective maintenance instructions shall also include explanations for the repair, adjustment, or replacement of all items. Schematic diagrams of electrical, mechanical, and electronic circuits; parts location illustrations, or other methods of parts location information; and photographs, and exploded and sectional views giving details of mechanical assemblies shall be provided as necessary to repair or replace equipment. For mechanical items requiring field repair, information shall be supplied on tolerances, clearances, wear limits and maximum bolt-down torques. Information on the loading and use of special off-line diagnostic programs, tools, and test equipment, and any cautions or warnings which shall be observed to protect personnel and equipment, shall also be included.

### **10.4.4 Parts information**

This information shall include the identification of each replaceable or field repairable module. Parts shall be identified on a list or drawing in sufficient detail for procurement of any repairable or replaceable part. These parts shall be identified by their industrial, generic part numbers, and shall have second source referencing whenever possible.

## **10.5 Test**

Test documentation by the supplier shall consist of a system test plan, test procedures, and certified test reports on tests described in clause 9.. The test plan shall state what equipment configuration will be tested, when it will be tested, which tests will be run, and who will conduct and witness the tests. The test procedures shall define the operating steps and expected results. The test report shall record all test results.

## Annex A Master station/RTU interconnections

### (Informative)

#### A.1 Single master station

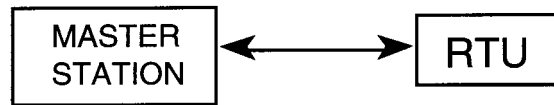

Figure A.1 —Single master station, single RTU

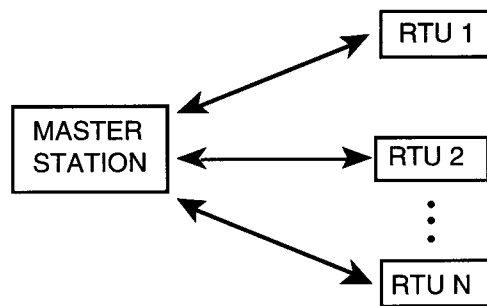

Figure A.2 —Single master station, single RTU

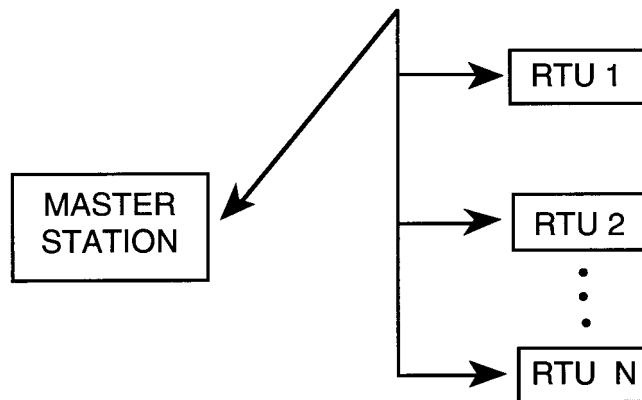

Figure A.3 —Single master station, multiple RTU(s), party-line circuit

## A.2 Multiple master stations

Master stations could communicate with one another.

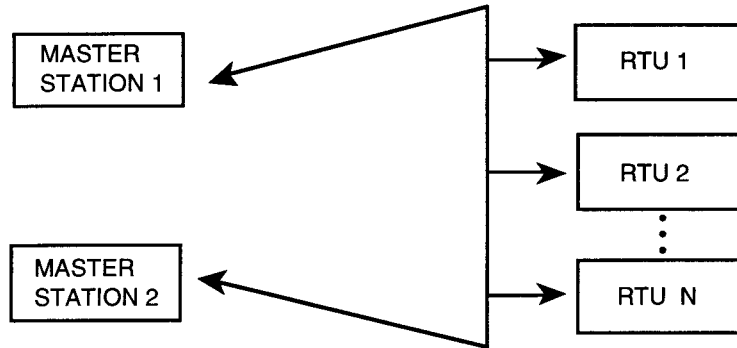

Figure A.4 —Dual master stations, multiple RTU(s), looped party line

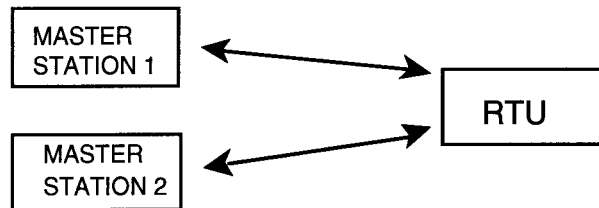

Figure A.5 —Dual master stations, single dual ported RTU, radial circuit

### A.3 Multiple master stations, multiple RTU(s)

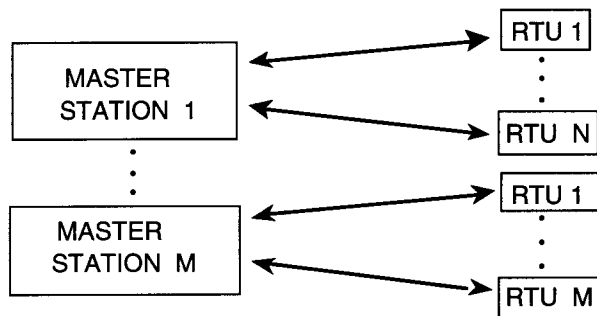

Figure A.6 —Multiple master stations, multiple RTU(s) (single ported RTU(s))

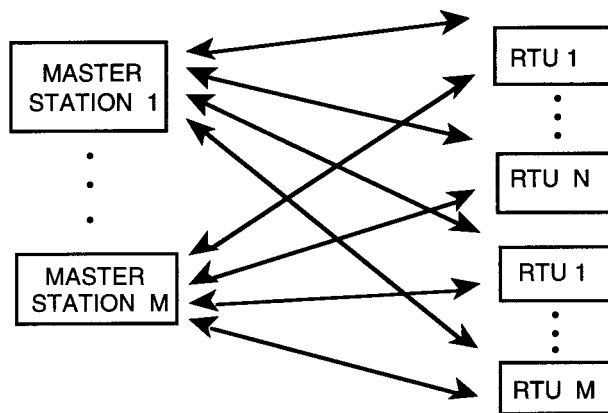
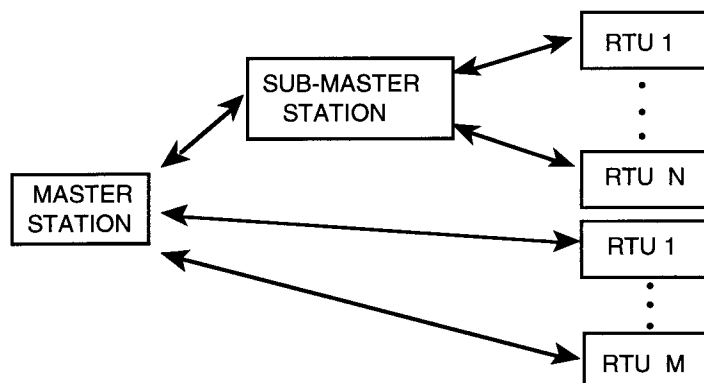

Figure A.7 —Multiple master stations, multiple RTU(s) (dual ported RTU(s))

**A.4 Combination systems**



**Figure A.8 —Single master station, single sub-master station, multiple RTU(s)**

Sub-master stations could communicate with one another.

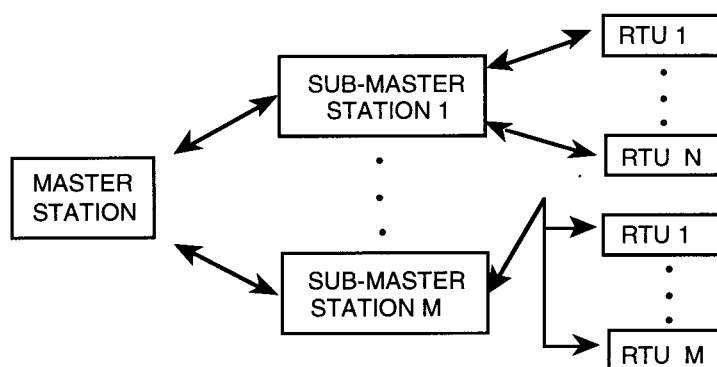

**Figure A.9 —Single master station, multiple sub-master stations, multiple RTU(s)**

## Annex B Channel loading calculation

### (Informative)

The channel routine load factor should be calculated for each master station to RTU communication channel using the following procedure:

- a) Compile a list of all periodic data and control transactions that will be required between the master station and all RTUs attached to the channel when the input/output point counts of those RTUs have been fully expanded. Each transaction is defined as the uninterrupted sequence of master station and RTU messages that transfer one block of data or one group of control commands.
- b) Calculate the channel time required to service each listed transaction, assuming no communication errors. This calculation should be based on the characteristics of the communication protocol and the communication equipment, the intended channel data rate, and the channel configuration (i.e., two- or four-wire, dedicated or party-line). Any transaction that contains more than about 250 information bits should be subdivided appropriately.
- c) List the longest transactions of each type that must be completed within the shortest periodic update time interval "T." This list will contain
  - 1) One of each transaction with update interval (T)
  - 2) One in "n" of all transactions with update interval (nT)
  - 3) One in "m" of all transactions with update interval (mT) etc.
  - 4) One of the transactions with the longest update interval
- d) Sum the calculated channel time required for all of these transactions.
- e) Divide the calculated total time by (T). This is the "worst-case" routine channel load factor, L. If L exceeds about 0.6, the entire procedure should be repeated with appropriate changes to the channel data rate or RTU assignments.
- f) Check that the unused channel time,  $T(1-L)$ , is sufficient to permit the transfer of at least one additional maximum-length transaction to permit a retransmission or an event-driven data or control transfer.

An illustrative example of the calculation procedure is given in the six steps below.

*Step 1* List required periodic data and control transactions.

A generating plant and a switchyard RTU are to be serviced by one duplex party-line communication channel that will operate at 2400 b/s and use the IEEE Std 999-1992 data communication protocol. When fully expanded, these RTUs will include the following numbers of periodic 16-b input and generator raise/lower control points:

I/O points	RTU:	
	Plant	Yard
2 s analog input points	32	16
8 s analog input points	44	20
30 s analog input points	80	44
15 min accumulator input points	32	16
4 s generator raise/lower output points	6	0

The communication protocol services up to 12 16-b analog or accumulator input points or 3 generator raise/lower output points in a single transaction. The following periodic channel transactions will be required:

Transactions:	RTU	
	Plant	Yard
2 s analog inputs, 12-points	2	1
2 s analog inputs, 8 points	1	0
2 s analog inputs, 4 points	0	1
8 s analog inputs, 12 points	3	1
8 s analog inputs, 8 points	1	1
30 s analog inputs, 12 points	6	3
30 s analog inputs, 8 points	1	1
15 min accumulator freeze command	1	0
15 min accumulator inputs, 12 points	2	1
15 min accumulator inputs, 8 points	1	0
15 min accumulator inputs, 4 points	0	1
4 s generator raise/lower outputs	2	0

Status input data will be reported by exception with no periodic status change request to each RTU. One Accumulator Freeze command will be “broadcast” to both RTUs.

*Step 2* Calculate the channel times for each transaction type:

The transaction types identified in step 1 will require, from table A2 of Appendix A of IEEE Std 999-1992 , the following times in a duplex party-line channel at 2400 b/s:

Analog or accumulator data, 12 points	169 ms
Analog or accumulator data, 8 points	142 ms
Analog or accumulator data, 4 points	116 ms
Accumulator freeze command	30 ms
Generator raise/lower command	30 ms

*Step 3* List of longest transactions to be completed in the shortest periodic interval:

From the above lists, the following periodic transactions will be required during the most heavily loaded 2 s interval:

Periodic transactions				Time (ms)
All 2 s analog input transactions:				
12 points		3		507
8 points		1		142
4 points		1		116
One in two of 4 s generator controls:			(n = 2)	
3 points		1		30
One in four of 8 s analog input transactions:			(m = 4)	
12 points		1		169
8 points	(next longest)	1	(minimum of 1)	142
One in 15 of 30 s analog input transactions:			(p = 15)	
12 points	(longest)	1	(minimum of 1)	169
15 min accumulator freeze command:				30
One 15 min accumulator transaction:				
12 points	(longest)	1	(minimum of 1)	169

*Step 4* Sum the calculated channel times:

The sum of the above channel times is 1474 ms.

*Step 5* Calculate the worst-case channel load factor:

The worst-case channel load factor  $L$  is therefore  $1.474 / 2.000$  or  $0.737$ . This exceeds the suggested maximum value of  $0.6$ . Repeating the above procedure with the data rate increased to  $4800$  b/s reduces the calculated value of  $L$  to  $0.63$ . If, alternatively, these RTUs are serviced via two point-to-point (dedicated) communication channels both operated at  $2400$  b/s, the calculated values of  $L$  become  $0.404$  and  $0.311$  respectively.

*Step 6* Check the unused channel time:

The unused channel time in the worst-case  $2$  s interval is  $0.526$  s. This is sufficient for three additional maximum-length transactions each of  $0.169$  s, which may be sufficient unless extended additional transactions will be required, e.g., sequence-of-events records.

## Annex C Bibliography

### (Informative)

Only those publications that are referenced and are approved standards can be listed as references in clause 2 in this standard. There are many other publications that provide additional information, and these are listed below.

[B1] ANSI C2-1993, National Electrical Safety Code (NESC).<sup>10</sup>

[B2] ANSI C39.5-1974, American National Standard Safety Requirements for Electrical and Electronic Measuring and Controlling Instrumentation.

[B3] ANSI S1.23-1976 (R 1983), American National Standard Method for the Designation of Sound Power Emitted by Machinery and Equipment.

[B4] ANSI/ASTM D775-80, Method of Drop Test for Shipping Containers.<sup>11</sup>

[B5] ANSI/ASTM D999-75, Standard Methods for Vibration Test for Shipping Containers.

[B6] ANSI/ISA RP-55-1-1975, Hardware Testing for Digital Process Computers.<sup>12</sup>

[B7] ANSI/ISA S50.1-1975 (R 1982), Compatibility of Analog Signals for Electronic Industrial Process Instruments.

[B8] ANSI/NEMA ICS 6-1988, Enclosures for Industrial Control and Systems.

[B9] CBEMA/ESC-5/77/29, Limits in Methods of Measurement of Electromagnetic Emanations from Electronic Data-Processing and Office Equipment.<sup>13</sup>

[B10] EIA EMC B2-1968, EMC Specifications, Standards and Bibliography.<sup>14</sup>

[B11] EIA EMC B3-1968, Testing and Measurement Techniques for Electronic Equipment.

[B12] EIA EMC B4-1965, Designers Guide on Electromagnetic System Design of Electric Equipment.

[B13] EIA EMC B5-1964, Bonding of Electronic Equipment.

[B14] EIA EMC B6-1967, Grounding of Electronic Equipment.

[B15] EIA EMC B10- 1966, Enclosures of Electronic Equipment.

[B16] EIA EMC B8-1965, Cabling of Electronic Equipment.

[B17] EIA EMC B9-1966, Filtering of Electronic Equipment.

<sup>10</sup>The NES C is available from the Institute of Electrical and Electronics Engineers, 445 Hoes Lane, P.O. Box 1331, Piscataway, NJ 08855-1331, USA.

<sup>11</sup>ASTM publications are available from the Customer Service Department, American Society for Testing and Materials, 1916 Race Street, Philadelphia, PA 19103, USA.

<sup>12</sup>ISA publications are available from the Instrument Society of America, 67 Alexander Drive, PO Box 12277, Research Triangle Park, NC 27709, USA.

<sup>13</sup>CBEMA publications are available from the Computer and Business Equipment Manufacturers Association, 1828 L Street NW, Washington, DC 20036, USA.

<sup>14</sup>The following EIA EMC sources have been withdrawn: [B10], [B11], [B12], [B13], [B14], [B15], [B16], [B17], and [B18]. However, they are available from from Global Engineering, 1990 M Street NW, Suite 400, Washington, DC, 20036, USA.

- [B18] EIA EMC B10-1967, Electromagnetic Susceptibility.
- [B19] EIA RS-422-A-1978, Electrical Characteristics of Balanced Voltage Digital Interface Circuits.
- [B20] FCC Code of Federal Regulations (CFR) Title 47, FCC Rules Part 15, Subparts A and B: clause 15.3—Definitions; clause 15.101—Equipment Authorization of Unintended Radiators; clause 15.103—Exempted Devices; clause 15.107—Conducted Limits; clause 15.109—Radiated Limits.
- [B21] Gaushell, D. J., Frisbie, W. L., and Kuchefski, M. H., “Analysis of Analog Data Dynamics for Supervisory Control and Data Acquisition System,” IEEE Paper 82 SM 304-4.
- [B22] IEC 68-2-6-1982, Test Fc and Guidance: Vibration (sinusoidal).<sup>15</sup>
- [B23] IEEE Std 4-1978, IEEE Standard Techniques for High-Voltage.<sup>16</sup>
- [B24] IEEE Std 518-1982, IEEE Guide for the Installation of Electrical Equipment to Minimize Noise Inputs to Controllers from External Sources (ANSI).
- [B25] IEEE C62.45-1987, IEEE Guide on Surge Testing for Equipment Connected to Low-Voltage AC Power Circuits (ANSI).
- [B26] IEEE Tutorial Course Text 91 EHO 337-6 PWR, “Fundamentals of Supervisory Systems.”
- [B27] IEEE Tutorial Video Tape HVO 245-1-POT, “Fundamentals of Supervisory Systems.”
- [B28] Koenig, D. F., “In Service Availability of the AEP System Control Center,” IEEE Paper 87 WM 059-9.
- [B29] Lloyd and Lipow. *Reliability, Management, Methods, and Mathematics*. Englewood Cliffs, NJ: Prentice-Hall, 1962.
- [B30] OSHA FR vol. 37, Occupational Safety and Health Standards, Oct. 18, 1972.<sup>17</sup>
- [B31] Uniform Building Code (UBC)-1988.<sup>18</sup>

---

<sup>15</sup>IEC publications are available from IEC Sales Department, Case Postale 131, 3 rue de Varembe, CH-1211, Genève 20, Switzerland/Suisse. IEC publications are also available in the United States from the Sales Department, American National Standards Institute, 11 West 42nd Street, 13th Floor, New York, NY 10036, USA.

<sup>16</sup>IEEE Std 4-1978 has been withdrawn; however, copies can be obtained from the IEEE Standards Department, 445 Hoes Lane, P.O. Box 1331, Piscataway, NJ 08855-1331, USA.

<sup>17</sup>OSHA publications are available from the US Department of Labor, Occupational Safety and Health Administration, 200 Constitution Avenue NW, Washington, DC 20210, USA.

<sup>18</sup>The Uniform Building Code (UBC) publication is available from the International Conference of Building Officials, 5360 South Workman Mill Road, Whittier, CA 90601, USA.